

# TORQUE TOOLS



Designed & Built  
in Britain.

The Power of Precision

formerly **TORQUELEADER**

EDITION 2

# The Power of Precision

Welcome to our 2017 catalogue. It contains information about the world's most advanced range of torque tools, produced in the UK by Gedore Torque (formerly Torqueleader).

For the past 80 years, the world's most sophisticated engineering, manufacturing and technology businesses have depended upon our products to build, maintain and repair some of the most amazing things on earth. We are confident that this catalogue will maintain that tradition.

## **When accuracy and consistency really matter**

Engineering and manufacturing businesses depend upon the accurate measurement and application of torque to nuts, bolts and threaded fasteners. Adherence to the correct torque specification ensures process conformity, product quality, product safety and reliability.

That's why when accuracy and consistency really matter, our customers choose Gedore Torque products. You'll find our tools in industries such as aerospace, aviation, automotive and telecommunications, being used in environments including production, quality control, research & development and servicing.

## **A commitment to excellence, innovation and customer service**

With distributors and customers in more than 51 countries, we are a global business. And as part of the Gedore Group, the world's largest group of tool specialists, our new name reflects the world-class standards to which we operate.

While our name has changed, our commitment to excellence, innovation and customer service remains the same. From our base in the UK, Gedore Torque will continue to design and manufacture a comprehensive range of industry-leading torque tools, delivering the accuracy and reliability our customers need, as well as first-class advice, service and technical support.

If we can help you to benefit from the power of precision, please get in touch.

Front cover 'An extraordinary tale of engineering imagination.'<sup>\*</sup>

*When Airbus built the A380, the world's largest passenger aircraft, they*

*chose Gedore Torque tools to ensure absolute precision. \*The Guardian newspaper*





**BT Tower 'A unique feat of engineering'\***

*When the BT Tower opened in 1966, it was the tallest building in London. Since then, telecommunications has been one of Gedore Torque's most important industry sectors.*

\* Gavin Patterson, BT CEO



### A place for precision

For the past 80 years, all our torque tools have been designed and manufactured at our United Kingdom site, located 35 miles outside London.

Gedore Torque has built upon our proud engineering traditions and highly-skilled workforce with a multi-million pound investment in the most up-to-date manufacturing technology. Every tool is still assembled by hand, ready to provide years of accurate, reliable service.

We are within easy reach of our customers and distributors, close to the UK's motorway network, London airports and the Channel tunnel and ports. London Heathrow Airport is 30 miles away, London Gatwick Airport 35 miles and Dover 95 miles.





## Everything in one location

Our 28,000 square feet site has been at the forefront of UK torque tool design and manufacture since 1937. Today, the same location is home to the world's most advanced and fully-integrated torque tool manufacturing facility.

Every aspect of our business is based here: Research & Development, Procurement, Manufacture, Assembly and Despatch. Our UKAS Calibration Laboratory ensures absolute accuracy, while our sales, marketing and customer service teams ensure that customers are always at the heart of our business.

Most importantly, the expertise and skills of our 70-strong team are always focused on the needs of our customers for increasingly efficient, innovative and reliable ways of measuring, applying and calibrating torque.

Everything we do conforms to exacting standards, both internal and external, including ISO and UKAS accreditations for our on site calibration laboratory. The quality of our people, process and facilities is your guarantee that our tools will deliver unsurpassed accuracy, quality and durability.





# Contents

Welcome to the world's most advanced and comprehensive range of Torque Tools, applications and services.

We are confident that these can provide the accuracy and reliability you need, for just about any torque application, in most industries.

If you require further assistance or information, please contact us, using the details below.



**Power and precision** At 200 mph, absolute accuracy and total precision really matter. We have supplied tools to every F1 racing team for more than 20 years.

## Torque Measuring Tools 8-15

Torque Screwdrivers and Wrenches that measure the level of torque that has been applied to a nut, bolt or threaded fastening. Used in Research & Development, Quality Auditing and Production Improvement.

## Torque Application Tools 16-57

Torque Screwdrivers and Wrenches that apply a set torque to a fastener. Torque Application Tools will slip, break or click to signal when the set torque is reached. Used for Production Processes, Service and Repair.

## Torque Multipliers 58-67

Our new Torque Multiplier product range enables each torque wrench to achieve a wider range of torque output, becoming more versatile and more productive.

## Torque Calibration Tools 68-79

Tools that are used for the testing, calibration and recalibration of Torque Tools, to ensure accurate and consistent operation. Used in production lines for Quality Control and in Calibration Laboratories.

## Torque Special Projects 80-83

Custom Tools and Tool Kits for the most exacting and specialised torque applications. Can also be supplied as Private Label, to meet user branding specifications.

## Torque Accessories 84-95

A wide range of Accessories, all compatible with our Torque Screwdrivers and Accessories. Custom accessories to meet specific application or operational needs.

## Technical Support 96-103

Unparalleled technical information, services and support. A worldwide network of factory-trained distributors. On-site Calibration Laboratory. Quality Assurance and Standards. Torque information.

## For more information:

Tool Selector [www.gedore-torque.com/tool-selector](http://www.gedore-torque.com/tool-selector)

Videos [www.youtube.com/gedore-torque](http://www.youtube.com/gedore-torque)

Email [salesandrepairs@gedore-torque.com](mailto:salesandrepairs@gedore-torque.com)

Telephone +44 (0)1483 894 476

# Torque Measuring Tools

## Introduction

Torque Measuring Tools are used in many manufacturing and engineering businesses to check, determine or apply the correct level of torque, using a dial or digital readout. They perform a crucial role in Audit, Inspection, Production, Quality Control, Research & Development and Servicing environments.

Engineering and manufacturing depend upon the accurate application of torque to nuts, bolts and fasteners. In fact, torque is essential for process conformity, product safety and total reliability: service problems and product failure can often be the result of insufficient or excessive torque. Gedore Torque Measuring Tools minimise these problems by ensuring that the correct torque settings can be applied and checked, with absolute and repeatable accuracy.





## Types of Measuring Tool

Torque Measuring Tools are available as Torque Screwdrivers or Torque Wrenches. They are fitted with a dial, or digital readout, which enables Torque to be measured as it is applied (Track mode) or when the maximum torque value has been reached (Peak mode).

## The application of Torque Measuring Tools

Torque Measuring Tools are used in many engineering, manufacturing and service environments, where adherence to the correct level of torque is essential for process conformity.

In Research & Development, Torque Measuring Tools can be used to determine what level of torque should be applied to a nut or bolt.

They can also be used in Auditing, Inspection and Quality Control in a manufacturing environment, to ensure that the correct level of torque has been applied.

Torque Measuring Tools can also be used to give absolute and repeatable accuracy in Production and Servicing, where operators may be required to tighten fasteners to various torque values.

## Quality Auditing Tests

There are three main ways in which Torque Measuring Tools can be used for Quality Audit purposes.

**Measurement.** This is used to verify the torque value of a previously tightened fastener. A clear mark is made on the surface of the nut, bolt or screw and continued onto the surface being clamped. This acts as a reference point. The fastener must then be untightened and then retightened until the marks are again in line. The torque value can then be read from the torque tool display.

**Just Move Test.** This is used to determine the torque setting of a previously tightened fastener. Using a torque measuring tool, a tightening torque is applied to the fastener until movement is just seen or felt. This torque is deemed to be a good indication of the original torque applied to the fastener.

**Break Loose Test.** This is used for checking the torque applied to a previously tightened fastener. Torque is applied in the direction that loosens the fastener and the torque is recorded at the point the fastener breaks loose. This value is an indication of the torque at which the fastener was originally tightened and is typically 20-30% lower than the tightening torque.

## TT Dial Measuring Torque Screwdrivers

Torque range from 0.1 to 5 N.m

The Gedore Torque range of Dial Measuring Torque Screwdrivers is designed for torque evaluation and torque verification, in order to ensure process conformity, product safety and absolute reliability. These low cost and versatile tools provide accuracy,

reliability and economy in a wide range of Maintenance and Repair, Quality Control, Research & Development and Assembly operations in any engineering or manufacturing environment.



TT 100 FH

### INDUSTRY SECTORS

#### Maintenance & Repair



Aerospace



Military



Utilities

#### Quality Control



Aerospace



Automotive



Packaging

## Versatile Torque Measuring Screwdrivers for any manufacturing environment

**Absolute accuracy.** Unique torsion bar mechanism to ensure total precision

**Dual scale.** Dial provides efficient measurement in Metric and Imperial torque units in both directions, delivering flexibility and minimising tool investment

**Ease of use.** Lightweight materials. Tools can be used by operators at any skill level

**Long tool life.** High quality, robust construction: stainless steel shaft, attractive coloured aluminium handle and sturdy dial

**Measure Process Conformity.** Unique memory function enables these tools to carry out the Just Move and Break Loose Quality Auditing Tests

**No risk of tool damage.** Overload Protection System with unique positive contact mechanism

**Operational versatility.** Torque can be measured as it is applied (Track mode) or when the maximum torque value has been recorded (Peak mode)



### Additional features





Calibration Service enables tools to be kept accurate and up to date.  
**See page 98**

Two year warranty provides additional peace of mind

Range of accessories provides versatility. **See pages 84-95**

**For more information:** Tool Selector; [gedore-torque.com/tool-selector](http://gedore-torque.com/tool-selector) Telephone; +44 (0) 1483 894 476  
Videos; [www.youtube.com/gedore-torque](http://www.youtube.com/gedore-torque) Email; [salesandrepairs@gedore-torque.com](mailto:salesandrepairs@gedore-torque.com)

Want to know how to use this tool?  
**YouTube**  
Watch our video

Order Code	Model	← Calibrated Range →				Drive	k mm	g	Accuracy	ISO 6789 Class	
		ISO	Imperial	Imperial	Imperial						
<b>017400</b>	TT 50 FH	10-50 cN.m	2 cN.m	14-70 ozf-in	2 ozf-in		178	190	+/- 6%	1D	✓
<b>017500</b>	TT 100 FH	20-100 cN.m	4 cN.m	28-140 ozf-in	4 ozf-in		178	190	+/- 6%	1D	✓
<b>017600</b>	TT 250 FH	50-250 cN.m	10 cN.m	4-20 lbf-in	0.5 lbf-in		250	465	+/- 6%	1D	✓
<b>017700</b>	TT 500 FH	100-500 cN.m	20 cN.m	8-40 lbf-in	1 lbf-in		250	465	+/- 6%	1D	✓



Dial

# Dial Measuring Torque Wrenches

Torque range from 0.8 to 2000 N.m



BDS 80 E



ADS 25 S

## INDUSTRY SECTORS

### Maintenance & Repair



Aerospace



Military



Utilities

### Quality Control



Aerospace



Automotive



Packaging

The Gedore Torque range of Dial Measuring Torque Wrenches is designed to verify or monitor torque, in order to ensure process conformity, product safety and absolute reliability. The main pointer on the dial captures the finishing torque applied to a fastener with a memory pointer. These low cost, durable and versatile tools can be used for Maintenance, Repair, Quality Control and Assembly in any engineering or manufacturing environment.



Durable storage case for ADS and BDS models



# ADS, BDS, CDS, DDS & EDS

Signal versions available. All ADS models are **EPA compliant**

## Robust and versatile tools Dial Measuring Torque Wrenches

- Dual scale.** Dial provides effective measurement in Metric and Imperial torque units in both directions, delivering flexibility and minimising tool investment
- Ease of use.** Tools can be used by operators at any skill level
- Long tool life.** High quality construction and robust design with a two year warranty

- No risk of tool damage.** Overload Protection System. Recessed dial minimises damage to the dial display
- Versatile usage.** Use for Maintenance, Repair, Assembly and Quality Control
- Wide range of applications.** Tightening and untightening measurement is possible, with double-ended ratchet as standard (except EDS versions)

### Additional features

- Calibration Service enables tools to be kept accurate and up to date. **See page 98**
- Special extension spanners. **See page 95**
- Optional audio visual signal system. Clear indication is given when the target torque has been reached

**For more information:** Tool Selector; [gedore-torque.com/tool-selector](http://gedore-torque.com/tool-selector) Telephone; +44 (0) 1483 894 476  
 Videos; [www.youtube.com/gedore-torque](http://www.youtube.com/gedore-torque) Email; [salesandrepairs@gedore-torque.com](mailto:salesandrepairs@gedore-torque.com)

Want to know how to use this tool?  
  
 Watch our video

Order Code	Model	ISO	Calibrated Range			Drive	k	mm	kg	Accuracy	ISO 6789 Class	Signal	
			ISO	Imperial	Imperial								
010100	ADS 4	0.8-4.0 N.m	0.1 N.m	7-35 lbf.in	1 lbf.in	1/4	244	0.52	+/- 3%	1B	X	✓	
010108	ADS 4 S	0.8-4.0 N.m	0.1 N.m	7-35 lbf.in	1 lbf.in	1/4	244	0.52	+/- 3%	1B	✓	✓	
010120	ADS 8	1.6-8.0 N.m	0.25 N.m	14-75 lbf.in	1 lbf.in	1/4	244	0.52	+/- 3%	1B	X	✓	
010128	ADS 8 S	1.6-8.0 N.m	0.25 N.m	14-75 lbf.in	1 lbf.in	1/4	244	0.52	+/- 3%	1B	✓	✓	
010140	ADS 12 D	2.4-12 N.m	0.5 N.m	24-120 lbf.in	2 lbf.in	1/4	244	0.52	+/- 3%	1B	X	✓	
010148	ADS 12 DS	2.4-12 N.m	0.5 N.m	24-120 lbf.in	2 lbf.in	1/4	244	0.52	+/- 3%	1B	✓	✓	
010160	ADS 12 A	2.4-12 N.m	0.5 N.m	24-120 lbf.in	2 lbf.in	3/8	244	0.52	+/- 3%	1B	X	✓	
010168	ADS 12 AS	2.4-12 N.m	0.5 N.m	24-120 lbf.in	2 lbf.in	3/8	244	0.52	+/- 3%	1B	✓	✓	
010180	ADS 25	5-25 N.m	1 N.m	48-240 lbf.in	10 lbf.in	3/8	244	0.52	+/- 3%	1B	X	✓	
010188	ADS 25 S	5-25 N.m	1 N.m	48-240 lbf.in	10 lbf.in	3/8	244	0.52	+/- 3%	1B	✓	✓	
010200	ADS 25 F	5-25 N.m	1 N.m	4-20 lbf.ft	0.5 lbf.ft	3/8	244	0.52	+/- 3%	1B	X	✓	
010208	ADS 25 FS	5-25 N.m	1 N.m	4-20 lbf.ft	0.5 lbf.ft	3/8	244	0.52	+/- 3%	1B	✓	✓	
010220	ADS 40	8-40 N.m	1 N.m	72-360 lbf.in	10 lbf.in	3/8	244	0.52	+/- 3%	1B	X	✓	
010228	ADS 40 S	8-40 N.m	1 N.m	72-360 lbf.in	10 lbf.in	3/8	244	0.52	+/- 3%	1B	✓	✓	
010240	ADS 40 F	8-40 N.m	1 N.m	6-30 lbf.ft	1 lbf.ft	3/8	244	0.52	+/- 3%	1B	X	✓	
010248	ADS 40 FS	8-40 N.m	1 N.m	6-30 lbf.ft	1 lbf.ft	3/8	244	0.52	+/- 3%	1B	✓	✓	
010300	BDS 80 A	16-80 N.m	2 N.m	12-60 lbf.ft	1 lbf.ft	3/8	435	1.35	+/- 3%	1B	X	X	
010380	BDS 80 AS	16-80 N.m	2 N.m	12-60 lbf.ft	1 lbf.ft	3/8	440	1.47	+/- 3%	1B	✓	X	
010320	BDS 80 E	16-80 N.m	2 N.m	12-60 lbf.ft	1 lbf.ft	1/2	435	1.36	+/- 3%	1B	X	X	
010400	BDS 80 ES	16-80 N.m	2 N.m	12-60 lbf.ft	1 lbf.ft	1/2	440	1.49	+/- 3%	1B	✓	X	
010410	BDS 100 EF	20-100 N.m	2 N.m	14-70 lbf.ft	2 lbf.ft	1/2	515	1.41	+/- 3%	1B	X	X	
010415	BDS 100 E	20-100 N.m	2 N.m	168-840 lbf.in	24 lbf.in	1/2	515	1.41	+/- 3%	1B	X	X	
010340	BDS 160	32-160 N.m	2.5 N.m	24-120 lbf.ft	2 lbf.ft	1/2	515	1.41	+/- 3%	1B	X	X	
010420	BDS 160 S	32-160 N.m	2.5 N.m	24-120 lbf.ft	2 lbf.ft	1/2	520	1.54	+/- 3%	1B	✓	X	
010360	BDS 200	40-200 N.m	5 N.m	30-160 lbf.ft	5 lbf.ft	1/2	515	1.41	+/- 3%	1B	X	X	
010440	BDS 200 S	40-200 N.m	5 N.m	30-160 lbf.ft	5 lbf.ft	1/2	520	1.54	+/- 3%	1B	✓	X	
010520	CDS 400 S	80-400 N.m	10 N.m	60-300 lbf.ft	10 lbf.ft	3/4	710	3.20	+/- 3%	1B	✓	X	
010620	DDS 800 S	160-800 N.m	20 N.m	120-600 lbf.ft	20 lbf.ft	3/4	1000	4.90	+/- 3%	1B	✓	X	
010700	EDS 1400 S	280-1400 N.m	25 N.m	200-1000 lbf.ft	25 lbf.ft	1	2040	16.7	+/- 3%	1B	✓	X	
010720	EDS 2000 S	400-2000 N.m	50 N.m	300-1500 lbf.ft	50 lbf.ft	1	2040	16.7	+/- 3%	1B	✓	X	

## Torcotronic Digital Torque Wrench with Angle

Torque range from 10 to 350 N.m

Torcotronic Digital Torque Wrenches provide highly accurate and controlled bi-directional tightening, suitable for Production, Quality Auditing, Research & Development, and Maintenance and Repair applications. These microprocessor-controlled tools have

built-in memory which stores data for download to analysis software. A comprehensive range of accessories ensures that these robust, versatile precision assembly tools provide accuracy across a wide range of applications.

### INDUSTRY SECTORS

#### Maintenance & Repair



Aerospace



Military



Utilities

#### Quality Control



Aerospace



Automotive



Packaging





## Robust, versatile tightening - plus data collection and auditing capability

**Accuracy.** Exceptionally high levels of accuracy of +/-1% of reading between 10% and 100% of full scale

**Bi-directional tightening.** Supplied with reversible ratchet as standard

**Control.** High levels of accuracy give confidence that the tightening process is under control, hence also controlling rework and warranty costs with the added benefit of five programmable preset values

**Data collection.** The built-in memory can store 2,000 data points ready for download to analysis software. This also makes the tools faster and easier to use

**Long tool life.** High quality construction and robust design

**Process traceability.** Historic data storage and management features of easy to use PC software, available in 11 languages

**Versatility.** Tools integrate with 9x12 and 14x18 wrench fittings. Torque and angle capability ensures suitability for a broad range of applications across Production, Quality Auditing, Research & Development, and Maintenance and Repair

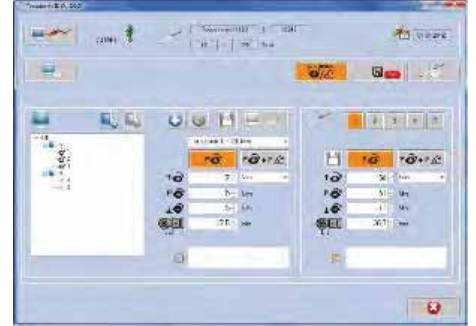

Software supplied as standard



Torcotronic 350 with Angle

**For more information:** Tool Selector; [gedore-torque.com/tool-selector](http://gedore-torque.com/tool-selector) Telephone; +44 (0) 1483 894 476  
Videos; [www.youtube.com/gedore-torque](http://www.youtube.com/gedore-torque) Email; [salesandrepairs@gedore-torque.com](mailto:salesandrepairs@gedore-torque.com)

Want to know how to use this tool?

**YouTube**

Watch our video

Order Code	Model	← Calibrated Range →		Drive	Adaptors	k mm	kg	Accuracy	ISO 6789 Class
		ISO	Imperial						
021640	120	10-120 N.m	7-88 lbf-ft	1/2	9x12	565	1.01	+/- 1%	1C
021650	350	70-350 N.m	51-258 lbf-ft	1/2	14x18	701	1.18	+/- 1%	1C



# Torque Application Tools

## Introduction

Gedore Torque offers the world's most comprehensive range of Torque Application Tools.

Torque Application Tools are used to apply a set torque to a fastener. When used, Torque Applying Tools will slip, break or click to signal to the operator when the set torque is reached.

Torque Application Tools are available as both screwdrivers and wrenches, with a wide torque range, to suit all application requirements. Choose from Preset Tools, that enable the consistent application of the same level of torque, or Calibrated Scale Tools, that enable a range of different torque settings to be applied.

Screwdrivers are available in a choice of aluminium, with its lighter weight and durability, or plastic, with an ergonomic hand grip for easier operator use.

All Torque Application Tools are guaranteed to deliver the correct torque every time, with absolute accuracy.

## Types of Torque Application Tools

**Preset Tools.** Preset tools are ideal in environments that require the same torque to be applied to a fastener time after time. They can be used by operators of any skill level, as the level of torque applied by the tool is pre-set using a Calibration Analyser.

**Calibrated Scale Tools.** Calibrated Scale Tools are ideal for use in situations where a range of different torque settings need to be applied. These types of tools have a visible scale that allows the user to adjust them to their desired torque setting.

## The principles underlying Torque Tool Mechanisms

### Slipping Tools... Overtightening Impossible

When the preset torque value is reached, (as indicated by the dotted line in the graph) a mechanism in these tools cause the application of torque to cease and the tools slip free.

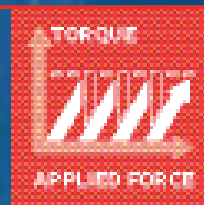

### Breaking Tools... Overtightening Unlikely

When the preset torque value is reached, (as indicated by the dotted line in the graph) these tools break at a specific point along their length. The movement is approximately 20°.

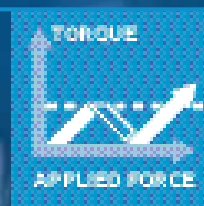

### Clicking Tools... Overtightening Possible

When the preset torque value is reached, (as indicated by the dotted line in the graph) the operator will hear and feel a click.

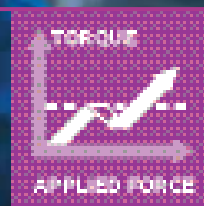



# TLS

## Aluminium TLS Preset Torque Screwdrivers

Torque range from 0.02 to 13.6 N.m

A range of compact aluminium preset torque screwdrivers, each of which delivers the correct torque accurately and repeatedly.

All tools are also available with One Way (O/W) clockwise torque and anti clockwise torque.

The models in this range include: TLS 0022, Minor, Standard & TLS 1360. Technical details of all models are given on pages 18-21.

These durable, versatile and lightweight tools can be used for Assembly, Maintenance and Servicing in any engineering or manufacturing environment.

### Slipping Mechanism

Incorrect tightening is impossible



Minor FH

### INDUSTRY SECTORS

Manufacturing



Automotive



Electronics



Military



Consumer Products



Order Code	Model	Range		Drive	k mm	g	Repeatability	ISO 6789 Class	Colour
		ISO	Imperial						
015200	Minor FH	14-135 cN.m	1.2-12 lbf.in		111	210	+/- 6%	2F	Blue
015205	Minor FH O/W	14-135 cN.m	1.2-12 lbf.in		125	300	+/- 6%	2F	Blue
015600	Standard FH	50-400 cN.m	4.4-36 lbf.in		127	280	+/- 6%	2F	Blue
015605	Standard FH O/W	50-400 cN.m	4.4-36 lbf.in		127	300	+/- 6%	2F	Blue
015890	TLS 1360 FH	2.5-13.6 N.m	22-120 lbf.in		137	325	+/- 6%	2F	Blue
015895	TLS 1360 FH O/W	2.5-13.6 N.m	22-120 lbf.in		137	400	+/- 6%	2F	Blue
015999	Pack of four interchangeable coloured end caps (supplied free with all TLS Screwdrivers except 0022)								

## Lightweight, high quality TLS Preset Torque Screwdriver range

### Absolute accuracy and consistency.

Accurate process control is ensured by eliminating under and over tightening due to the proven slipping mechanism

**Ease of use.** Tools can be used by operators at any skill level, due to unique slipping mechanism

### Improved production quality.

Accurate torque application reduces the likelihood of warranty and rework

### Increased production efficiency.

Lightweight aluminium construction and smooth reset action of the tools increase production efficiency by reducing operator fatigue

**Long tool life.** High quality, robust construction

**Operational versatility.** These versatile tools are ideal for a wide range of applications, with wide torque range and one way slipping action option



Standard FH



TLS 1360 FH



## Additional features

TLS range (excluding 0022 range) supplied as standard with a quick converter adaptor to 1/4" male square drive

For more information on ESD compliant versions. **See page 25**

Comprehensive range of Accessories, Bits and Blades. **See pages 88-89**

TLS Screwdrivers can be customised to your exacting requirements. **See page 83**

TLS Screwdrivers are supplied with a pack of four interchangeable coloured end caps to allow easy identification of what tool is set to what torque value, hence making a job more efficient. (Order Code: 015999) ●●●● (not supplied with TLS 0022 screwdrivers)

**For more information:** Tool Selector; [gedore-torque.com/tool-selector](http://gedore-torque.com/tool-selector) Telephone; +44 (0) 1483 894 476  
Videos; [www.youtube.com/gedore-torque](http://www.youtube.com/gedore-torque) Email; [salesandrepairs@gedore-torque.com](mailto:salesandrepairs@gedore-torque.com)

Want to know how  
to use this tool?  
**YouTube**  
Watch our video



## Aluminium TLS Preset Torque Screwdrivers

Torque range from 0.02 to 13.6 N.m

A range of compact aluminium preset torque screwdrivers, each of which delivers the correct torque accurately and repeatedly.

All tools are also available with One Way (O/W) clockwise torque and anti clockwise torque.

The models in this range include: TLS 0022, Minor, Standard & TLS 1360. Technical details of all models are given on pages 18-21.

These durable, versatile and lightweight tools can be used for Assembly, Maintenance and Servicing in any engineering or manufacturing environment.



Order Code	Model	Range		Drive	k mm	g	Repeatability	ISO 6789 Class	Colour
		ISO	Imperial						
015000	TLS 0022 Micro FH	4-22 cN.m	5.7-32 ozf.in		76	050	+/- 6%	2F	Blue
015080	TLS 0022 FH	2-22 cN.m	2.8-32 ozf.in		104	072	+/- 6%	2F	Blue
015085	TLS 0022 FH O/W	2-22 cN.m	2.8-32 ozf.in		116	085	+/- 6%	2F	Blue



## Lightweight, high quality TLS Preset Torque Screwdriver range

### Absolute accuracy and consistency.

Accurate process control is ensured by eliminating under and over tightening due to the proven slipping mechanism

**Ease of use.** Tools can be used by operators at any skill level, due to unique slipping mechanism

**Improved production quality.** Accurate torque application reduces the likelihood of warranty and rework

### Increased production efficiency.

Lightweight aluminium construction and smooth reset action of the tools increase production efficiency by reducing operator fatigue

**Long tool life.** High quality, robust construction

**Operational versatility.** These versatile tools are ideal for a wide range of applications, with wide torque range and one way slipping action option



### Slipping Mechanism

Incorrect tightening is impossible



TLS 0022 MICRO

TLS 0022 FH



### Additional features

For more information on ESD compliant versions. **See page 25**

Comprehensive range of Accessories, Bits and Blades. **See pages 88-89**

TLS Screwdrivers can be customised to your exacting requirements. **See page 83**

**For more information:** Tool Selector; [gedore-torque.com/tool-selector](http://gedore-torque.com/tool-selector) Telephone; +44 (0) 1483 894 476  
Videos; [www.youtube.com/gedore-torque](http://www.youtube.com/gedore-torque) Email; [salesandrepairs@gedore-torque.com](mailto:salesandrepairs@gedore-torque.com)

Want to know how to use this tool?

**YouTube**

Watch our video

Pro

# Pro Preset Torque Screwdrivers

Torque range from 0.05 to 13.5 N.m

The Redefined Preset Torque Screwdriver range has been designed to complement our traditional accuracy, durability and quality with the benefits of a moulded plastic body and enhanced ergonomic design.

These durable, versatile and lightweight tools can be used for Assembly, Maintenance and Servicing in any engineering or manufacturing environment.

The models in this range include: ESD, Prime and Pro. Technical details of all models are given on pages 25-27.

## Slipping Mechanism

Incorrect tightening is impossible



## INDUSTRY SECTORS

### Manufacturing



Automotive



Electronics



Military



Consumer Products



## The Redefined Preset Torque Screwdriver range

### Absolute accuracy and consistency.

Accurate process control is ensured by eliminating under and over tightening due to the proven slipping mechanism

**Ease of use.** Tools can be used by operators at any skill level, due to unique slipping mechanism

### Improved production quality.

Accurate torque application reduces the likelihood of warranty and rework

### Increased production efficiency.

Dual formed moulded ergonomic handgrip is more suited to certain production techniques and provides comfort and grip to user. The smooth tool reset action increases production efficiency by reducing operator fatigue

**Long tool life.** High quality, robust construction. Many years of dependable service are provided by the robust design, especially if regularly calibrated

**Operational versatility.** These versatile tools are ideal for a wide range of applications, with wide torque range and one way slipping action option

To allow for customisation and clear identification interchangeable coloured end caps are available in packs of four (Order Code: 065800)



## Additional features

Calibration stickers can be easily applied to the purpose designed nose

The 1/4" female hexagon Pro range proves versatile with a quick conversion to male square 1/4" drive by using a convertor (Order Code: 029200)

For more information on EPA compliant versions. **See page 25**

Comprehensive range of Accessories, Bits and Blades. **See pages 88-89**

Pro Screwdrivers can be customised to your exacting requirements. **See page 83**

Tool presetting service. **See page 98**

**For more information:** Tool Selector; [gedore-torque.com/tool-selector](http://gedore-torque.com/tool-selector) Telephone; +44 (0) 1483 894 476  
Videos; [www.youtube.com/gedore-torque](http://www.youtube.com/gedore-torque) Email; [salesandrepairs@gedore-torque.com](mailto:salesandrepairs@gedore-torque.com)

Want to know how  
to use this tool?  
**YouTube**  
Watch our video



# Pro

## Pro Preset Torque Screwdrivers

Torque range from 0.05 to 13.5 N.m

Versatile Preset Torque Application Screwdrivers for any manufacturing environment

These tools complement our traditional accuracy, durability and quality with the benefits of a moulded plastic body and enhanced ergonomic design

Durable, versatile and lightweight tools that can be used for Assembly, Maintenance and Servicing in any engineering or manufacturing environment

Pro 450 and 1350 models come with T-Bars as standard to assist with higher torque

To allow for customisation and clear identification interchangeable coloured end caps are available in packs of four (Order Code: 065800)



Comprehensive range of Accessories, Bits and Blades. **See pages 88-89**

### Slipping Mechanism

Incorrect tightening is impossible

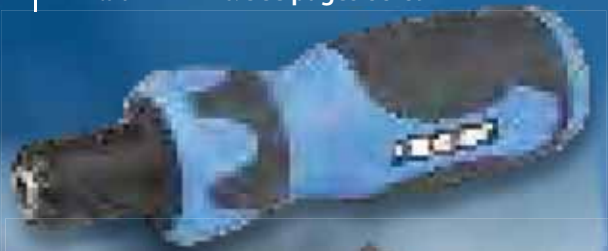

Pro 25 & 150



Pro 450 & 1350



T-Bar

# ESD Preset Torque Screwdrivers

Torque range from 0.05 to 13.5 N.m

## Preset Torque Application Screwdrivers for electronic component assembly

The ESD Preset Torque Screwdriver range is ideal for safe electronic component assembly as these tools are EPA compliant

Tools that complement our traditional accuracy, durability and quality with the benefits of a moulded plastic body and enhanced ergonomic design

ESD 450 and 1350 models come with T-Bars as standard to assist with higher torque

To allow for customisation and clear identification interchangeable coloured end caps are available in packs of four (Order Code: 065800)



### Slipping Mechanism

Incorrect tightening is impossible

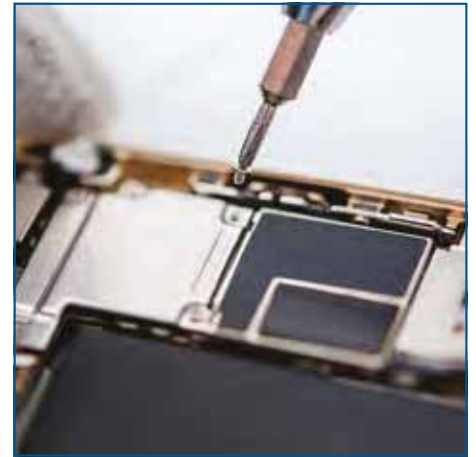

**For more information:** Tool Selector; [gedore-torque.com/tool-selector](http://gedore-torque.com/tool-selector) Telephone; +44 (0) 1483 894 476  
Videos; [www.youtube.com/gedore-torque](http://www.youtube.com/gedore-torque) Email; [salesandrepairs@gedore-torque.com](mailto:salesandrepairs@gedore-torque.com)

Want to know how to use this tool?

**YouTube**

Watch our video

Order Code	Gedore Ref	Model	Range		Drive	k	mm	x	g	Repeatability	ISO 6789 Class	T-Bar	
			ISO	Imperial									
065400	2927756	Pro 25 FH	0.05 - 0.25 N.m	0.45 - 2.2 lbf.in		132			210	+/- 6%	2F	X	X
065500	2927764	Pro 150 FH	0.2 - 1.5 N.m	1.8 - 13 lbf.in		132			210	+/- 6%	2F	X	X
065600	2927772	Pro 450 FH	0.5 - 4.5 N.m	4.5 - 40 lbf.in		140			230	+/- 6%	2F	✓	X
065700	2927780	Pro 1350 FH	2.5 - 13.5 N.m	22 - 120 lbf.in		140			230	+/- 6%	2F	✓	X
065405	2927799	ESD 25 FH	0.05 - 0.25 N.m	0.45 - 2.2 lbf.in		132			210	+/- 6%	2F	X	✓
065505	2927802	ESD 150 FH	0.2 - 1.5 N.m	1.8 - 13 lbf.in		132			210	+/- 6%	2F	X	✓
065605	2927810	ESD 450 FH	0.5 - 4.5 N.m	4.5 - 40 lbf.in		140			230	+/- 6%	2F	✓	✓
065705	2927829	ESD 1350 FH	2.5 - 13.5 N.m	22 - 120 lbf.in		140			230	+/- 6%	2F	✓	✓
065800	Pack of four interchangeable coloured end caps ● ● ● ●												



## Prime Preset Torque Screwdrivers

Torque range from 0.2 to 4.5 N.m

These tools have been specifically designed to provide a low cost product that is suitable for light or occasional use, or one-off applications. Can be used up to 2,000 cycles.

They have no certification and are not intended for regular or heavy use, where our Pro Preset range of preset screwdrivers should be selected.





## Low cost Preset Torque Application Screwdrivers, for one-off applications or light use

Prime Preset Torque Screwdrivers offer a low cost option for applications where a torque tool may not previously have been considered

They combine accuracy with the benefits of a moulded plastic body and ergonomic design, to remove the risk of under or over tightening. As well as the application of torque, they can also undo fasteners, as One Way (O/W) action is standard

A comprehensive range of Accessories, Bits and Blades is available.  
**See pages 88-89**



### Slipping Mechanism

Incorrect tightening is impossible



Prime 150

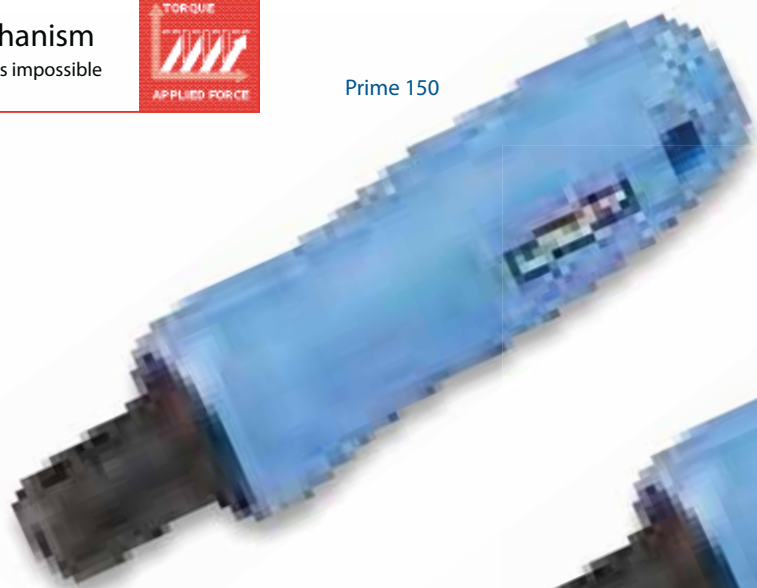

Prime 450

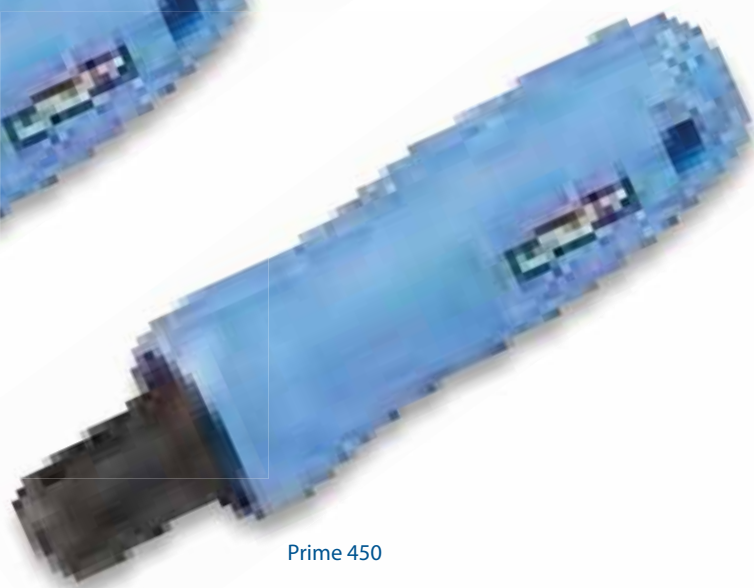

**For more information:** Tool Selector; [gedore-torque.com/tool-selector](http://gedore-torque.com/tool-selector) Telephone; +44 (0) 1483 894 476  
Videos; [www.youtube.com/gedore-torque](http://www.youtube.com/gedore-torque) Email; [salesandrepairs@gedore-torque.com](mailto:salesandrepairs@gedore-torque.com)

Want to know how to use this tool?



Order Code	Model	Range		Drive	k mm	g	Repeatability
		ISO	Imperial				
<b>065100</b>	Prime 150 FH	0.2 - 1.5 N.m	1.8 - 13 lbf.in	$\frac{1}{4}$	138	198	+/- 10%
<b>065200</b>	Prime 450 FH	0.5 - 4.5 N.m	4.5 - 40 lbf.in	$\frac{1}{4}$	138	198	+/- 10%

# TLS

## TLS Preset Clean Room Torque Screwdrivers

Torque range from 0.04 to 13.6 N.m

Clean Room (CRS) Class 100 Compliant

Designed specifically for use in Clean Rooms, to protect precision products from contamination during assembly, utilising PTFE impregnated sealed anodised aluminium handles.

External steel components are either high grade stainless steel or coated to inhibit corrosion thereby utilising suitable surface treatments and incorporating high performance seals in their design.

### INDUSTRY SECTORS

Manufacturing



Automotive



Electronics



Military



Consumer Products



## Preset Torque Screwdrivers for Clean Rooms

- Increased operator comfort from the soft reset action of the tool
- Complete control of the tightening process is achieved. Both under and over tightening are eliminated by our unique slipping mechanism
- Suitable for use by operators of any skill level, as these tools will repeatedly deliver the set torque without the need for operator intervention

CRS Torque Screwdrivers are preset type torque tools. They must be set to the required value by using a Torque Analyser. **See page 78 for details**

Comprehensive range of Accessories, Bits and Blades. **See pages 88-89**

### Slipping Mechanism

Incorrect tightening is impossible



**For more information:** Tool Selector; [gedore-torque.com/tool-selector](http://gedore-torque.com/tool-selector) Telephone; +44 (0) 1483 894 476  
Videos; [www.youtube.com/gedore-torque](http://www.youtube.com/gedore-torque) Email; [salesandrepairs@gedore-torque.com](mailto:salesandrepairs@gedore-torque.com)

Want to know how to use this tool?

**YouTube**

Watch our video

Order Code	Model	Range		Drive	k mm	g	Repeatability	ISO 6789 Class	Colour
		ISO	Imperial						
<b>015089</b>	CRS 100-0022 FH	2-22 cN.m	6-32 ozf.in	$\frac{1}{4}$	104	072	+/- 6%	2F	Grey
<b>015209</b>	CRS 100-0135 FH	14-135 cN.m	0.9-12 lbf.in	$\frac{1}{4}$	111	210	+/- 6%	2F	Grey
<b>015609</b>	CRS 100-0406 FH	50-400 cN.m	4.4-36 lbf.in	$\frac{1}{4}$	127	280	+/- 6%	2F	Grey
<b>015939</b>	CRS 100-1360 FH	2.5-13.6 N.m	22-120 lbf.in	$\frac{1}{4}$	137	325	+/- 6%	2F	Grey





# ESD Electric Torque Screwdrivers

Torque range from 0.05 to 9.81 N.m

ESD Electric Torque Screwdrivers are ideal for the accurate and consistent application of torque in high volume production environments. These tools are durable,

efficient, effective and easy to use in any manufacturing business. Special features also make them suitable for the assembly of electronic and plastic products.

EF 120



K 450



HTC 35 Controller

HF Series



## INDUSTRY SECTORS

Manufacturing



Automotive



Electronics



Utilities



Consumer Products

# ESD Electric Torque Screwdrivers

## EF 120, K 450 & HF Series

Electric Torque Screwdrivers, for accurate, effective and consistent torque application

**Absolute accuracy and consistency.**

**Ease of use.** The tools are easy to set up and require minimal operator training. The operator is able to work effectively and safely, as these tools are comfortable to use because of their ergonomic design. This can be further enhanced by pairing the driver with a tool weight balancer or torque reaction arm

**Electronic assembly.** Maximises the production yields of electronic assemblies as these tools protect the assembly from static shocks due to their ESD compliance

**Improved production efficiency.** Accurate torque application reduces the likelihood of rework and scrap by delivering controlled repeatable torque through features like 'slow start' mode that minimises cross threading

**Long tool life and effective production.**

These tools maximise productivity by keeping downtime to a minimum, as they are constructed from durable robust materials and designed to last

**Plastic assembly.** Ensures the quality of plastic assembly tightening by combating joint relaxation through use of the 'doublehit' repeat torque mode

Please note: These tools must be used in conjunction with a controller listed below



STC 30+ Controller

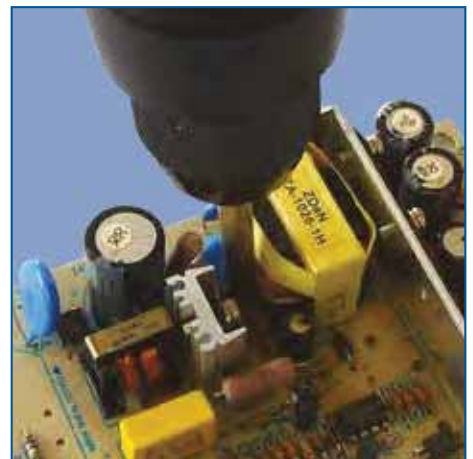
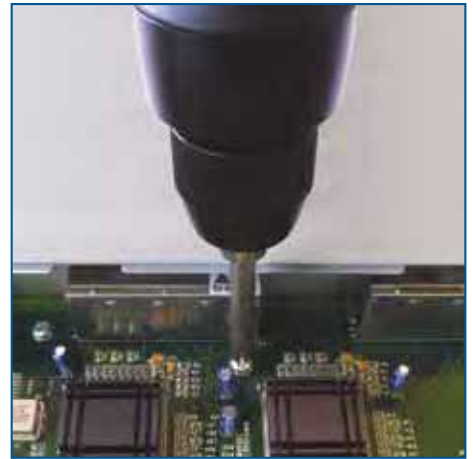

### Additional features

Details of Accessories and Power Bits. **See pages 84-95**

Set and calibrate your Screwdriver with CAPTURE Hub Torque Calibration Analyser. **For more details see page 72** or visit [www.gedore-torque.com](http://www.gedore-torque.com)

Torque counter balancer are available on request

Tamper proof cover to suit K series tools, order code: 090200.  
EF tools, order code: 090210

**For more information:** Tool Selector; [gedore-torque.com/tool-selector](http://gedore-torque.com/tool-selector) Telephone; +44 (0) 1483 894 476  
Videos; [www.youtube.com/gedore-torque](http://www.youtube.com/gedore-torque) Email; [salesandrepairs@gedore-torque.com](mailto:salesandrepairs@gedore-torque.com)

Want to know how to use this tool?  
**YouTube**  
Watch our video

Order Code	Model	Range		RPM		Drive	g		CE	Repeatability
		ISO	Imperial	Hi	Low					
<b>090010</b>	EF 120	0.19-1.17 N.m	1.7-10.4 lbf.in	700	460		311	✓	✓	+/- 10%
<b>090150</b>	K 450	0.5-4.4 N.m	4.3-39 lbf.in	550	330		595	✓	✓	+/- 10%
<b>090160</b>	HF	3.9-9.81 N.m	34.7-87 lbf.in	550	150		810	✓	✓	+/- 10%
<b>090001</b>	HTC 35 Transformer (Compatible with HF Series)			-	-	-	816	-	✓	+/- 10%
<b>090000</b>	STC 30+ Controller (Compatible with EF 120 & K 450 Series)			-	-	-	950	-	✓	+/- 10%

Ergo

# Ergo Quickset Adjustable Torque Screwdrivers

Torque range from 0.08 to 9 N.m

Ergo Quickset Adjustable Torque Screwdrivers are calibrated scale tools that can be used for the accurate and consistent application of torque in any manufacturing, engineering or servicing environment. They are EPA compliant, for safe electronic component assembly, and ergonomically designed for enhanced

operator comfort. Unique Slipping Technology ensures that the risk of over or under tightening is eliminated. Their adjustability and wide range of torque make them suitable for a broad range of applications.

QSN 120 FH

QSN 600 FH

T-Bar is not included with the Ergo Quickset Screwdriver Range

## INDUSTRY SECTORS

Maintenance & Repair



Aerospace



Electronics



Military



Consumer Products





## Ergo Quickset Adjustable Torque Screwdrivers (ISO and Imperial Scales)

### Absolute accuracy and consistency.

Accurate process control is ensured by eliminating under and over tightening due to the unique Slipping Technology

**Calibrated scale.** A visible scale allows the user to adjust the tool to their desired torque setting, enabling a range of different torque settings to be applied

**Ease of use.** Tools can be used with confidence by operators at any skill level, due to unique slipping mechanism

**Easy to set up.** Fast and accurate to set, using the quick and clear to read micrometer style setting scale with unique locking feature

**Electronics.** Ideal for safe electronic component assembly as this tool is EPA compliant for use in Electrostatically Sensitive Areas

### Improved production quality.

Accurate torque application reduces the likelihood of warranty and rework

### Increased production efficiency.

Increased operator comfort and productivity, from the smooth reset action of the tool and the ergonomic handle design

**Long tool life.** High quality, robust construction. Many years of dependable service are provided by the robust design and hard-wearing materials, that include stainless steel and aluminium

**Operational versatility.** These versatile tools are ideal for a wide range of applications, due to their adjustability and wide torque range



### Additional features

Optional Lock On T-Bar for larger models of screwdriver, provides extra leverage (Order Code: P29530)

Can be supplied as part of a Service Repair Kit

Tool can be kept accurate and up to date with our Calibration service.

**See page 98 for details**

### Slipping Mechanism

Incorrect tightening is impossible



**For more information:** Tool Selector; [gedore-torque.com/tool-selector](http://gedore-torque.com/tool-selector) Telephone; +44 (0) 1483 894 476

Videos; [www.youtube.com/gedore-torque](http://www.youtube.com/gedore-torque) Email; [salesandrepairs@gedore-torque.com](mailto:salesandrepairs@gedore-torque.com)

Want to know how to use this tool?

**YouTube**

Watch our video

Order Code	Model	← Calibrated Range →		Drive	k mm	g	Repeatability	ISO 6789 Class	Adjusting Lock Colour	
		Range	للسلسل							
<b>060700</b>	QSN 40 FH	8-40 cN.m	1 cN.m	$\frac{1}{4}$	159	124	+/- 6%	2D	Blue	✓
<b>060740</b>	QSA 60 FH	12-60 ozf.in	1 ozf.in	$\frac{1}{4}$	159	124	+/- 6%	2D	Blue	✓
<b>060720</b>	QSA 4 FH	0.8-4 lbf.in	0.1 lbf.in	$\frac{1}{4}$	159	124	+/- 6%	2D	Blue	✓
<b>060100</b>	QSN 120 FH	20-120 cN.m	1 cN.m	$\frac{1}{4}$	183	230	+/- 6%	2D	Blue	✓
<b>060140</b>	QSA 160 FH	20-160 ozf.in	1 ozf.in	$\frac{1}{4}$	183	230	+/- 6%	2D	Blue	✓
<b>060120</b>	QSA 12 FH	2-12 lbf.in	0.1 lbf.in	$\frac{1}{4}$	183	230	+/- 6%	2D	Blue	✓
<b>060300</b>	QSN 600 FH	1-6 N.m	0.1 N.m	$\frac{1}{4}$	196	335	+/- 6%	2D	Blue	✓
<b>060320</b>	QSA 50 FH	10-50 lbf.in	1 lbf.in	$\frac{1}{4}$	196	335	+/- 6%	2D	Blue	✓
<b>060500</b>	QSN 900 FH	4-9 N.m	0.1 N.m	$\frac{1}{4}$	196	335	+/- 6%	2D	Blue	✓
<b>060520</b>	QSA 80 FH	30-80 lbf.in	1 lbf.in	$\frac{1}{4}$	196	335	+/- 6%	2D	Blue	✓

Quickset

# Quickset Adjustable Torque Screwdrivers

Torque range from 0.2 to 9 N.m

Quickset Adjustable Torque Screwdrivers are calibrated scale tools that can be used for the accurate and consistent application of torque in any manufacturing, engineering or servicing environment. Their adjustability and wide range of torque make them

suitable for a broad range of applications. These tools are durable, easy to use and the unique Slipping Technology means that the risk of over or under tightening is eliminated.

Quickset 6 FH



T-Bar is not included with the Ergo Quickset Screwdriver Range

**Slipping Mechanism**  
Incorrect tightening is impossible



## INDUSTRY SECTORS

Maintenance & Repair



Aerospace



Electronics



Military



Consumer Products



## Quickset Adjustable Torque Screwdrivers (ISO and Imperial Scales)

### Absolute accuracy and consistency.

Accurate process control is ensured by eliminating under and over tightening due to the unique Slipping Technology

**Calibrated scale.** A visible scale allows the user to adjust the tool to their desired torque setting, enabling a range of different torque settings to be applied

**Ease of use.** Tools can be used with confidence by operators at any skill level, due to unique slipping mechanism

**Easy to set up.** Fast and accurate to set, using the quick and clear to read micrometer style setting scale

**Improved production quality.** Accurate torque application reduces the likelihood of warranty and rework

### Increased production efficiency.

Increased operator comfort and productivity, from the smooth reset action of the tool and the ergonomic design

**Long tool life.** High quality, robust construction. Many years of dependable service are provided by the robust design and hard-wearing materials, that include stainless steel and aluminium

**Operational versatility.** These versatile tools are ideal for a wide range of applications, due to their adjustability and wide torque range



### Additional features

Accessories. **See pages 84-95**

EPA compliant alternative available. **See page 32**

Optional Lock On T-Bar for larger models of screwdriver, provides extra leverage when required. (Order Code: P29530)

Tool can be kept accurate and up to date with our Calibration service. **See page 98 for details**

**For more information:** Tool Selector; [gedore-torque.com/tool-selector](http://gedore-torque.com/tool-selector) Telephone; +44 (0) 1483 894 476  
Videos; [www.youtube.com/gedore-torque](http://www.youtube.com/gedore-torque) Email; [salesandrepairs@gedore-torque.com](mailto:salesandrepairs@gedore-torque.com)

Want to know how to use this tool?

**YouTube**

Watch our video

Order Code	Model	← Calibrated Range →		Drive	k mm	g	Repeatability	ISO 6789 Class	Colour
		Range	Imperial						
<b>016040</b>	Quickset Minor Metric FH	20-120 cN.m	1 cN.m	$\frac{1}{4}$	169	165	+/- 6%	2D	Blue
<b>016060</b>	Quickset Minor Imp FH	20-120 ozf.in	1 ozf.in	$\frac{1}{4}$	169	165	+/- 6%	2D	Blue
<b>016070</b>	Quickset Minor lbf.in FH	2-12 lbf.in	0.1 lbf.in	$\frac{1}{4}$	169	165	+/- 6%	2D	Blue
<b>016500</b>	Quickset 6 FH	1-6 N.m	0.1 N.m	$\frac{1}{4}$	184	335	+/- 6%	2D	Blue
<b>016600</b>	Quickset 50 FH	5-50 lbf.in	1 lbf.in	$\frac{1}{4}$	184	335	+/- 6%	2D	Blue
<b>016700</b>	Quickset 9 FH	4-9 N.m	0.1 N.m	$\frac{1}{4}$	184	335	+/- 6%	2D	Blue
<b>016800</b>	Quickset 80 FH	30-80 lbf.in	1 lbf.in	$\frac{1}{4}$	184	335	+/- 6%	2D	Blue

## Dual Scale Quickset Screwdrivers Available:

Order Code	Model	← Calibrated Range →			Drive	k mm	g	Repeatability	ISO 6789 Class	Colour	
		ISO	Imperial	Imperial							
<b>016011</b>	Quickset Minor DS	20-120 cN.m	1 cN.m	20-120 ozf.in	1 ozf.in	$\frac{1}{4}$	160	158	+/- 6%	2D	Blue
<b>016550</b>	Quickset 6 DS	1-6 N.m	0.1 N.m	5-50 lbf.in	1 lbf.in	$\frac{1}{4}$	169	340	+/- 6%	2D	Blue



# TSN

## TSN Preset Slipping Torque Wrenches

Torque range from 1 to 125 N.m

High quality tools that have been designed and precision-engineered to meet the stringent demands of manufacturing businesses in most industries. The tools have been given a full facelift, resulting in a contemporary, high quality appearance appropriate to high technology

manufacturing lines. The unique slipping mechanism eliminates under and over tightening in Production, hence ensuring absolute precision. EPA compliant.



TSN 55

TSN 10/90

**Slipping Mechanism**  
Incorrect tightening is impossible



### INDUSTRY SECTORS

Manufacturing



Automotive



Aerospace



Military



Consumer Products



# Preset Slipping Torque Wrenches

Models: TSN 5, 10, 25, 55 & 125

## Absolute accuracy and consistency.

Accurate process control is ensured by eliminating under and over tightening, regardless of operator's hand position, due to the unique Slipping Technology

**Ease of use.** Tools can be used with confidence by operators at any skill level, due to unique slipping mechanism

**Electronics.** Ideal for safe electronic component assembly as this tool is EPA compliant for use in Electrostatically Sensitive Areas. See table for details

## Improved production efficiency.

Reduces the likelihood of warranty and rework by assuring process control through accurate and repeatable torque setting due to its adjusting system

**Improved Process Control.** Process control can be further enhanced by using the Switch Operated Signal Torque versions (Sw) to confirm the correct torque has been applied to a particular fastener (see pages 42-43)

**Long tool life.** High quality, robust design and construction, further guaranteed by a two year warranty

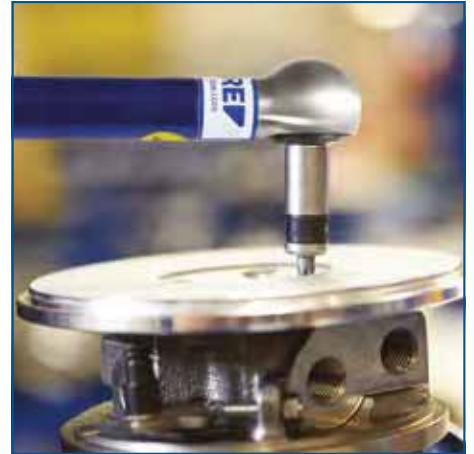

## Additional features

Accessories. See pages 84-95

EPA compliant alternative available. See table below

For details of Sockets. See page 87 or visit [www.gedore-torque.com](http://www.gedore-torque.com)

For Switch Operated Signal Torque versions (Sw). See pages 42-43

TSN Wrenches are preset type torque tools. They must be set to the required value by using a Torque Analyser like the DREMOTEST E or Capture Calibration System. See page 78 for details

TSN 25 versions come with either 1/4" or 3/8" Drive

**TSN 5 & 10 use new bearing technology.** The bearings are manufactured from self-lubricating polymer material, meaning that they are extremely wear resistant

**Non-slip grip.** TSN 5 & 10 utilise glass filled Nylon 66, giving non-slip grip. This means greater durability, anti-static properties and EPA compliance, for use in Electrostatically Sensitive areas.



Working principle of the Gedore Torque Slipping Wrenches

Order Code	Model	Range		Drive	k	mm	kg	Repeatability	ISO 6789 Class	
		ISO	Imperial							
011301	TSN 5/45	1-5 N.m	10-45 lbf.in	1/4"	185	0.19	+/- 6%	2C	✓	
011401	TSN 10/90	2-10 N.m	20-90 lbf.in	1/4"	185	0.19	+/- 6%	2C	✓	
011017	TSN 25 D	5-25 N.m	4-18 lbf.ft	1/4"	216	0.34	+/- 4%	2C	✓	
011019	TSN 25 A	5-25 N.m	4-18 lbf.ft	3/8"	216	0.34	+/- 4%	2C	✓	
011035	TSN 55	15-55 N.m	10-40 lbf.ft	3/8"	324	0.80	+/- 4%	2C	✗	
011055	TSN 125	40-125 N.m	30-90 lbf.ft	1/2"	460	1.36	+/- 4%	2C	✗	



# TBN

## TBN Preset Breaking Torque Wrenches

Torque range from 0.4 to 200 N.m

TBN Preset Breaking Torque Wrenches are robust production tools that reduce the chance of over-tightening, because of the unique Breaking Mechanism. They can be used for a wide range of applications, with

a choice of compatible interchangeable end fittings. Their durable yet compact design makes them easy to use in restricted spaces in any manufacturing or maintenance environment.



TBN 135

TBN 2

### Breaking Mechanism

Incorrect tightening is unlikely



### INDUSTRY SECTORS

Maintenance & Repair



Military

Manufacturing



Automotive



Aerospace



Electronics



Military



Consumer Products





# TBN Preset Breaking Torque Wrenches

## TBN 2, 10, 25, 65, 135 & 200



**Improved accuracy, consistency and control.** Accurate process control is ensured by reducing the risk of under and over tightening, due to unique Breaking Technology. This gives the operator more time to react once the target torque is reached

**Compact slimline design.** This maximises productivity in restricted space applications

**Compatible End Fittings.** A range of interchangeable end fittings is available, making this an extremely versatile tool. **See pages 84-86 for details**

**Ease of use.** Tools can be used with confidence by operators at any skill level, due to the unique Breaking Technology

**Increased production efficiency.** Increased operator comfort and productivity, from the ergonomic design, that includes lightweight materials and moulded handgrip

**Long tool life.** High quality, robust design and construction minimise tool replacement and downtime costs

Rectangular fitting version also available. **See table below**

### Additional features

TBN 2 and 10 Wrenches will be supplied with a Calibration Certificate when ordered with an attached end fitting and pre-set











For EPA options, **see table below**

**For more information:** Tool Selector; [gedore-torque.com/tool-selector](http://gedore-torque.com/tool-selector) Telephone; +44 (0) 1483 894 476  
Videos; [www.youtube.com/gedore-torque](http://www.youtube.com/gedore-torque) Email; [salesandrepairs@gedore-torque.com](mailto:salesandrepairs@gedore-torque.com)

Want to know how to use this tool?

**YouTube**

Watch our video

Order Code	Model	Range		Drive	k mm	kg	Repeatability	ISO 6789 Class	
		ISO	Imperial						
<b>011100</b>	TBN 2	0.4-2 N.m	3.5-18 lbf.in	Captive Pin	105	0.11	+/- 6%	2C	✓
<b>011110</b>	TBN 2 G	0.4-2 N.m	3.5-18 lbf.in		133	0.13	+/- 6%	2C	✓
<b>011200</b>	TBN 10	1-10 N.m	9-89 lbf.in	Captive Pin	105	0.13	+/- 6%	2C	✓
<b>011210</b>	TBN 10 G	1-10 N.m	9-89 lbf.in		133	0.15	+/- 6%	2C	✓
<b>050000</b>	TBN 25	5-25 N.m	4-18 lbf.ft		265	0.41	+/- 4%	2C	✗
<b>050010</b>	TBN 25 G	5-25 N.m	4-18 lbf.ft		265	0.41	+/- 4%	2C	✗
<b>050100</b>	TBN 65	10-65 N.m	7-48 lbf.ft		302	0.75	+/- 4%	2C	✗
<b>050110</b>	TBN 65 G	10-65 N.m	7-48 lbf.ft		302	0.75	+/- 4%	2C	✗
<b>050200</b>	TBN 135	27-135 N.m	18-100 lbf.ft		408	1.03	+/- 4%	2C	✗
<b>050210</b>	TBN 135 G	27-135 N.m	18-100 lbf.ft		408	1.03	+/- 4%	2C	✗
<b>050300</b>	TBN 200	40-200 N.m	29-147 lbf.ft		520	1.40	+/- 4%	2C	✗
<b>050310</b>	TBN 200 G	40-200 N.m	29-147 lbf.ft		520	1.40	+/- 4%	2C	✗

50V

# 50V Insulated Preset Torque Wrenches

Torque range from 0.4 to 25 N.m

These tools have been precision-engineered to provide absolute accuracy and user safety during electrical assembly and maintenance. Our unique breaking or slipping mechanism eliminates the risk of incorrect tightening and the compact tool design provides protection where there are electrically live components, up to 50V.

## Essential service and maintenance - with no power

Helicopters require frequent maintenance and servicing, in order to ensure continuous safe operation. Often, this work has to be carried out in remote locations, without access to power, meaning that it is not possible to use hydraulic or impact wrenches.

Gedore Torque tools provide precision torque control, making it easier and often safer to tighten and loosen threaded fasteners to the high standards critical to the performance and safety of civilian and military helicopters.

### INDUSTRY SECTORS

#### Manufacturing



Automotive



Utilities



Aerospace



Military



Consumer Products





# 50V insulated preset torque wrenches for electrical assembly

Torque range from 0.4 to 25 N.m

Performing business critical work accurately, easily - and safely

Many businesses, organisations and industries depend upon emergency backup power systems to provide a continuous supply of electricity in the event of the loss of mainstream power supply. Often, this is provided by banks of batteries, that need to be checked, maintained and replaced on a regular basis – including while they are in operation and therefore electrically ‘live’. Battery cells used to power all electric vehicles like the Tesla Model S or hybrids like BMW and Volkswagen all need to be maintained during their lifetime and most EV makers offer end-of-life vehicle recycling to ensure batteries and electrical parts are disposed of responsibly. Gedore Torque Insulated Torque Wrenches ensure that this essential work can be carried out accurately, easily and safely.



**Absolute accuracy and consistency.** Accurate process control is ensured by eliminating under and over tightening, due to the unique Breaking or Slipping Technology installed in the wrench

**Ease of use.** The small and compact design combined with the totally insulated body is ideal for use in restricted space where there are electrically live components

**Improved production efficiency.** Eliminates the possibility of product failure due to shorting, arcing or other electrical damage

**User safety.** Designed for use in low voltage and other battery applications where protection up to 50 volts is required. Double layer nonconductive PVC insulation provides protection against low voltage shorting

## Additional features

- Accessories. **See pages 84-95**
- These Wrenches are preset type torque tools. They must be set to the required torque value by using a Torque Analyser like the DREMOTEST E. **See page 78 for details**
- Tool pre-set at point of order
- Tool can be kept accurate and up to date with our Calibration service. **See page 98 for details**

### Slipping Mechanism

Incorrect tightening is impossible



### Breaking Mechanism

Incorrect tightening is unlikely



TBN 10 50V



**For more information:** Tool Selector; [gedore-torque.com/tool-selector](http://gedore-torque.com/tool-selector) Telephone; +44 (0) 1483 894 476  
Videos; [www.youtube.com/gedore-torque](http://www.youtube.com/gedore-torque) Email; [salesandrepairs@gedore-torque.com](mailto:salesandrepairs@gedore-torque.com)

Want to know how to use this tool?  
**YouTube**  
Watch our video

Order Code	Model	Range		Drive	k mm	kg	Repeatability
		ISO	Imperial				
011108	TBN 2 50V	0.4-2 N.m	3.5-18 lbf.in	1/4	105	0.17	+/- 6%
011208	TBN 10 50V	1-10 N.m	9-89 lbf.in	1/4	105	0.17	+/- 6%
011062	TSN 25 D 50V	5-25 N.m	4-18 lbf.ft	1/4	220	0.40	+/- 4%
011072	TSN 25 A 50V	5-25 N.m	4-18 lbf.ft	3/8	220	0.40	+/- 4%



## Switch Operated Signal Torque Wrenches

Torque range from 0.4 to 200 N.m

Switch Operated Signal Torque Wrenches are process control tools that provide absolute confidence that the correct level of torque has been applied. As well as the Slipping or Breaking Mechanism, that reduces or eliminates the risk of incorrect tightening, the tool also sends a signal each

time the wrench achieves its pre-set torque value. This makes these tools suitable for production line control or to provide a counting function, as they can be connected to the customers production systems.

TSN 25 A Sw

TBN 25 Sw

**Slipping Mechanism**  
Incorrect tightening is impossible



**Breaking Mechanism**  
Incorrect tightening is unlikely



### INDUSTRY SECTORS

Manufacturing



Automotive



Consumer Products



Aerospace



Military



# Switch Operated Signal Torque Wrenches

## Ranges: TSP, TSN & TBN

### Absolute accuracy and consistency.

Accurate process control is ensured by eliminating or reducing under and over tightening, due to the unique Slipping or Breaking Technology

**Better production control.** These wrenches confirm that the tightening process has been performed by validating that the torque wrenches have operated at a pre-set torque value. A signal is sent upon each successful activation of the wrench, that can be used to control production flow or count completed tightenings

**Cost effective.** These tools can easily be integrated into most Production Lines as the output signal is simply a switch opening and closing

**Ease of use.** Tools can be used with confidence by operators at any skill level, due to unique slipping or breaking mechanism

### Additional features

A Signal Delay Unit (SDU) can be used to reduce the risk of missing wrench activations by extending the time of the signal output

Two types of cables are available - either a 5 metre, straight cable (Order Code: D94402) or a 1.5 metre coiled cable (Order Code: D94406)

Universal Switch Module (Order Code: B25900) is connected via cable to the Production Line Control System

For End Fittings, **see pages 84-86**



Universal Switch Module  
Order Code: B25900



Signal Delay Unit (SDU)  
Order Code: C12870

Order Code	Model	Range		Drive	k mm* ↓	kg ↓	Repeatability	ISO 6789 Class
		ISO	Imperial					
056093	TSP 5 Sw	1-5 N.m	10-45 lbf.in	1/4	335	0.53	+/- 6%	2C
056103	TSP 10 Sw	2-10 N.m	20-90 lbf.in	1/4	335	0.53	+/- 6%	2C
011003	TSN 25 D Sw	5-25 N.m	4-18 lbf.ft	1/4	366	0.68	+/- 4%	2C
011013	TSN 25 A Sw	5-25 N.m	4-18 lbf.ft	3/8	366	0.68	+/- 4%	2C
011033	TSN 55 Sw	15-55 N.m	10-40 lbf.ft	3/8	474	1.14	+/- 4%	2C
011053	TSN 125 Sw	40-125 N.m	30-90 lbf.ft	1/2	610	1.70	+/- 4%	2C
011103	TBN 2 Sw	0.4-2 N.m	3.5-18 lbf.in	Captive Pin	255	0.45	+/- 6%	2C
011113	TBN 2 G Sw	0.4-2 N.m	3.5-18 lbf.in	9x12	133	0.13	+/- 6%	2C
011203	TBN 10 Sw	1-10 N.m	9-89 lbf.in	Captive Pin	255	0.47	+/- 6%	2C
011213	TBN 10 G Sw	1-10 N.m	9-89 lbf.in	9x12	133	0.15	+/- 6%	2C
050003	TBN 25 Sw	5-25 N.m	4-18 lbf.ft	16	415	0.75	+/- 4%	2C
050013	TBN 25 G Sw	5-25 N.m	4-18 lbf.ft	9x12	415	0.75	+/- 4%	2C
050103	TBN 65 Sw	10-65 N.m	7-48 lbf.ft	16	452	1.09	+/- 4%	2C
050113	TBN 65 G Sw	10-65 N.m	7-48 lbf.ft	9x12	452	1.09	+/- 4%	2C
050203	TBN 135 Sw	27-135 N.m	18-100 lbf.ft	16	558	1.68	+/- 4%	2C
050213	TBN 135 G Sw	27-135 N.m	18-100 lbf.ft	9x12	558	1.68	+/- 4%	2C
050303	TBN 200 Sw	40-200 N.m	29-147 lbf.ft	16	670	1.74	+/- 4%	2C
050313	TBN 200 G Sw	40-200 N.m	29-147 lbf.ft	14x8	670	1.74	+/- 4%	2C

\* Length of tool and switch not including cable

## Torcofix Production Clicker Torque Wrenches

Torque range from 5 to 200 N.m

Versatile Production tools, with a range of interchangeable end fittings, designed for accurate and repeated torque application. An audible click provides tightening process control.

### Clicking Mechanism

Incorrect tightening is possible

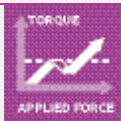

Torcofix 85 FS

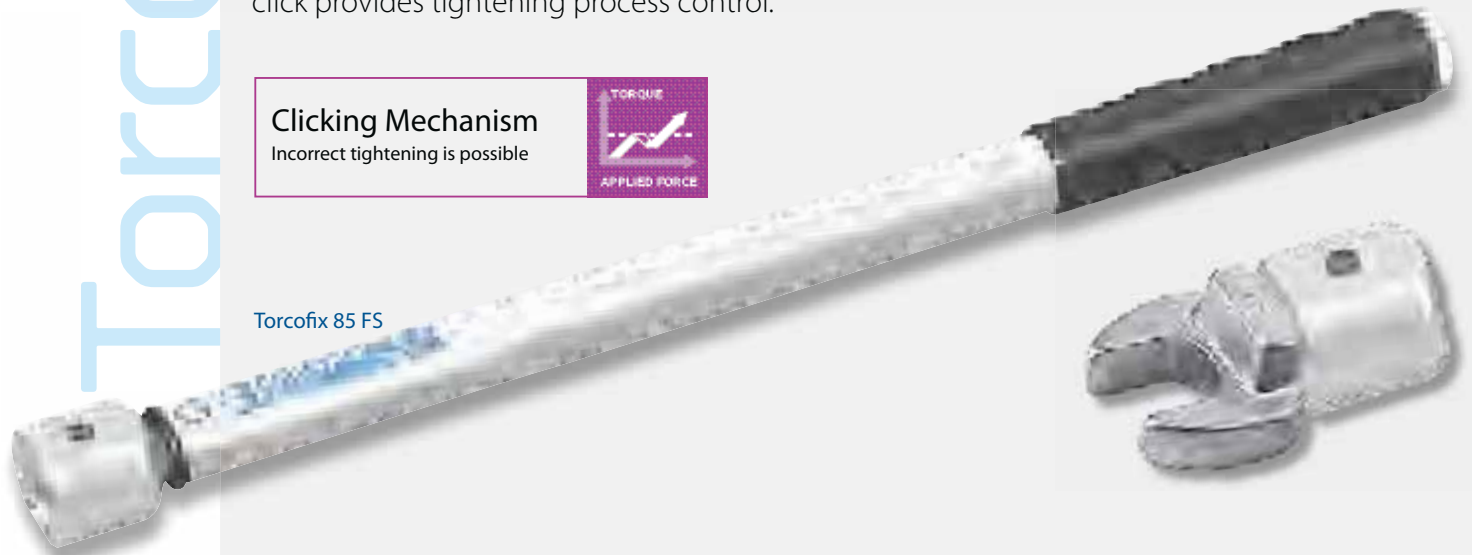

### INDUSTRY SECTORS

Maintenance & Repair



Automotive



Aerospace



Utilities



Consumer Products

**Audible click providing accurate process control.** The risk of under and over tightening is reduced, as a click can be heard and felt when the preset torque is reached

**Preset torque.** Enhanced tightening process control, as unauthorised adjustment of the level of torque is not possible. These tools must be set to the required torque value by using a Torque Analyser like the DREMOTEST E. **See page 78 for details**

**Long tool life.** High quality, robust design and construction, further guaranteed by a two year warranty

**Multiple industrial applications.** The versatile design allows the use of a range of end fittings and ratchets

Order Code	Model	Range		Drive	k mm	kg	Accuracy	ISO 6789 Class
		Range	lb/ft					
<b>7601960</b>	Torcofix 25 FS	5-25 N.m	3.7-18 lbf.ft		180	0.21	+/- 4%	2C
<b>7602180</b>	Torcofix 50 FS	10-50 N.m	7.5-37.5 lbf.ft		240	0.27	+/- 4%	2C
<b>7602850</b>	Torcofix 85 FS	17-85 N.m	12.5-65 lbf.ft		320	0.34	+/- 4%	2C
<b>7603580</b>	Torcofix 200 FS	40-200 N.m	30-150 lbf.ft		400	0.75	+/- 4%	2C



# New TSC Adjustable Slipping Torque Wrenches

Torque range from 1 to 10 N.m

Compact, versatile and lightweight tools which eliminate over-tightening in a wide range of industrial applications, including maintenance and repair. Calibrated scale allows for adjustment of torque. EPA compliant.



TSC 10

**Slipping Mechanism**  
Incorrect tightening is impossible

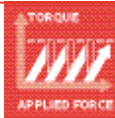

**Bearing Technology.** The new bearings are extremely wear resistant,utilizing a self-lubricating polymer material,which offers a heightened level of performance, while at the same time reducing the weight to improve the user experience

**Serviceability.** The full tool is user serviceable but as it contains moving parts we recommend periodic servicing to ensure your tool works correctly and to maximum efficiency

**Scale.** The new TSC incorporates a micrometer style fine adjustment, with a positive locking system providing fast, easy and accurate setting

**Grip.** Glass filled Nylon 66, non-slip grip for durability with anti -static properties giving the tool EPA compliance, for use in Electrostatically Sensitive areas

## INDUSTRY SECTORS

### Maintenance & Repair



Aerospace



Electronics

### Manufacturing



Automotive









Consumer Products

**For more information:** Tool Selector; [gedore-torque.com/tool-selector](http://gedore-torque.com/tool-selector) Telephone; +44 (0) 1483 894 476  
Videos; [www.youtube.com/gedore-torque](http://www.youtube.com/gedore-torque) Email; [salesandrepairs@gedore-torque.com](mailto:salesandrepairs@gedore-torque.com)

Want to know how to use this tool?

**YouTube**

Watch our video

Order Code	Model	← Calibrated Range →		Drive	k mm	g	Accuracy	ISO 6789 Class	
		Range							
059020	TSC 5	1-5 N.m	0.05 N.m		195	235	+/- 6%	2A	✓
059040	TSC 10	2-10 N.m	0.1 N.m		195	235	+/- 6%	2A	✓
059060	TSC 45	10-45 lbf.in	0.5 lbf.in		195	235	+/- 6%	2A	✓
059080	TSC 90	20-90 lbf.in	1.0 lbf.in		195	235	+/- 6%	2A	✓

ATB

# ATB Adjustable Breaking Torque Wrenches

Torque range from 0.5 to 10 N.m

Compact and versatile tools engineered to reduce the risk of under and over tightening in Production, Service and Repair. Calibrated scale allows for pre-setting of torque. EPA compliant.

ATB 5

ATB 10 G

Breaking Mechanism  
Incorrect tightening is unlikely



## INDUSTRY SECTORS

### Maintenance & Repair



### Manufacturing



# ATB Adjustable Breaking Torque Wrenches

## ATB 2.5, 5 & 10

**Accuracy and consistency.** Improved process control is ensured by reducing the risk of under and over tightening, due to the unique Breaking Technology

**Calibrated scale.** A visible micrometer style scale allows the user to adjust the tool quickly and easily to their desired torque setting, enabling a range of different torque settings to be applied

**Ease of use.** Can be used in restricted spaces through its compact design

**Electronics.** Ideal for safe electronic component assembly and servicing, as this tool is EPA compliant for use in Electrostatically Sensitive Areas

**Long tool life.** High quality, durable design and construction, minimises replacement and downtime costs

**Process Control.** Reduces the likelihood of warranty and rework by assuring process control through accurate and repeatable torque application

**Production efficiency.** Improved operator comfort and productivity, from the ergonomic design, which includes lightweight materials and moulded plastic handgrip

**Versatility.** Versatile tools ideal for Maintenance & Repair applications where a range of torques can be applied quickly and easily to a variety of fasteners and connectors



### Additional features

N.m or lbf.in versions come with either an 8 mm spigot or a 9x12 rectangular fitting

Can be supplied as part of a Customised Kit

For details of accessories, **see pages 84-95**

Tool can be kept accurate and up to date with our Calibration service. **See page 98 for details**



**For more information:** Tool Selector; [gedore-torque.com/tool-selector](http://gedore-torque.com/tool-selector) Telephone; +44 (0) 1483 894 476  
Videos; [www.youtube.com/gedore-torque](http://www.youtube.com/gedore-torque) Email; [salesandrepairs@gedore-torque.com](mailto:salesandrepairs@gedore-torque.com)

Want to know how to use this tool?

**YouTube**

Watch our video

Order Code	Model	Calibrated Range				Drive	k mm	kg	Accuracy	ISO 6789 Class	
		ISO		Imperial							
050520	ATB 2.5	50-250 cN.m	1.25 cN.m	-	-		190	0.24	+/- 6%	2A	✓
050525	ATB 2.5	-	-	4.5-22.5 lbf.in	0.1 lbf.in		190	0.24	+/- 6%	2A	✓
050527	ATB 2.5 G	50-250 cN.m	1.25 cN.m	-	-		192	0.27	+/- 6%	2A	✓
050532	ATB 2.5 G	-	-	4.5-22.5 lbf.in	0.1 lbf.in		192	0.27	+/- 6%	2A	✓
050500	ATB 5	1-5 N.m	0.025 N.m	-	-		220	0.29	+/- 6%	2A	✓
050505	ATB 5	-	-	10-45 lbf.in	0.25 lbf.in		220	0.29	+/- 6%	2A	✓
050507	ATB 5 G	1-5 N.m	0.025 N.m	-	-		230	0.29	+/- 6%	2A	✓
050512	ATB 5 G	-	-	10-45 lbf.in	0.25 lbf.in		230	0.29	+/- 6%	2A	✓
050550	ATB 10	2-10 N.m	0.05 N.m	-	-		220	0.30	+/- 6%	2A	✓
050555	ATB 10	-	-	20-90 lbf.in	0.5 lbf.in		220	0.30	+/- 6%	2A	✓
050557	ATB 10 G	2-10 N.m	0.05 N.m	-	-		230	0.30	+/- 6%	2A	✓
050562	ATB 10 G	-	-	20-90 lbf.in	0.5 lbf.in		230	0.30	+/- 6%	2A	✓



ATB

# ATB Adjustable Breaking Torque Wrenches

Torque range from 5 to 100 N.m

High quality, versatile, tools that have been designed and engineered to reduce the risk of under and over tightening in Production,

Service and Repair. The Calibrated Scale allows for pre-setting of torque.

ATB 100

ATB 25 showing N.m Scale

### Breaking Mechanism

Incorrect tightening is unlikely



## INDUSTRY SECTORS

### Maintenance & Repair



### Manufacturing



# ATB Adjustable Breaking Torque Wrenches

## ATB 25, 50 & 100

**Accuracy and consistency.** Improved process control is ensured by reducing the risk of under and over tightening, due to the unique Breaking Technology

**Calibrated scale.** A visible micrometer style scale allows the user to adjust the tool quickly and easily to their desired torque setting, enabling a range of different torque settings to be applied

**Long tool life.** High quality, durable design and construction, minimises replacement and downtime costs

**Process Control.** Reduces the likelihood of warranty and rework by assuring process control through accurate and repeatable torque application

**Production efficiency.** Improved operator comfort and productivity, from the ergonomic design, which includes lightweight materials and moulded plastic handgrip

**Versatility.** Versatile tools ideal for Maintenance & Repair applications where a range of torques can be applied quickly and easily to a variety of fasteners and connectors

### Additional features

1/4", 3/8" or 1/2" interchangeable ratchet heads come as standard

Available in N.m, lbf.in or lbf.ft versions

For details of Wrench End Fittings & Sockets. **See pages 84-86**

Tool can be kept accurate and up to date with our Calibration service. **See page 98 for details**



**For more information:** Tool Selector; [gedore-torque.com/tool-selector](http://gedore-torque.com/tool-selector) Telephone; +44 (0) 1483 894 476  
Videos; [www.youtube.com/gedore-torque](http://www.youtube.com/gedore-torque) Email; [salesandrepairs@gedore-torque.com](mailto:salesandrepairs@gedore-torque.com)

Want to know how to use this tool?

**YouTube**

Watch our video

Order Code	Model	ISO	Calibrated Range			Drive	k mm	kg	Accuracy	ISO 6789 Class
			ISO	Imperial	Imperial					
050636	ATB 25 D	5-25 N.m	0.1 N.m	-	-	1/4"	345	1.11	+/- 4%	2A
050641	ATB 25 D	-	-	50-250 lbf.in	1 lbf.in	1/4"	345	1.11	+/- 4%	2A
050646	ATB 25 D	-	-	4-20 lbf.ft	0.1 lbf.ft	1/4"	345	1.11	+/- 4%	2A
050638	ATB 25 A	5-25 N.m	0.1 N.m	-	-	3/8"	345	1.12	+/- 4%	2A
050643	ATB 25 A	-	-	50-250 lbf.in	1 lbf.in	3/8"	345	1.12	+/- 4%	2A
050648	ATB 25 A	-	-	4-20 lbf.ft	0.1 lbf.ft	3/8"	345	1.12	+/- 4%	2A
050685	ATB 50	10-50 N.m	0.25 N.m	-	-	3/8"	365	1.14	+/- 4%	2A
050690	ATB 50	-	-	120-440 lbf.in	2 lbf.in	3/8"	365	1.14	+/- 4%	2A
050695	ATB 50	-	-	7-37 lbf.ft	0.125 lbf.ft	3/8"	365	1.14	+/- 4%	2A
050735	ATB 100	20-100 N.m	0.5 N.m	-	-	1/2"	400	1.30	+/- 4%	2A
050740	ATB 100	-	-	240-880 lbf.in	4 lbf.in	1/2"	400	1.30	+/- 4%	2A
050745	ATB 100	-	-	14-74 lbf.ft	0.25 lbf.ft	1/2"	400	1.30	+/- 4%	2A

## Torcofix Adjustable Clicker Torque Wrenches

### Torque range from 1 to 750 N.m

Adjustable general tools for Service and Repair. Ideal for covering a wide number of tasks as the operator can adjust them to deliver a broad range of torques. An audible click informs user that correct torque has been applied. Choice of sockets.



Torcofix 100 K

#### Clicking Mechanism

Incorrect tightening is possible



#### INDUSTRY SECTORS

Maintenance & Repair



Automotive



Aerospace



Utilities



Consumer Products

**Audible click provides accuracy and control.** The risk of under and over tightening is reduced, as a click can be heard and felt when the preset torque is reached

**Choice of Drives.** Interchangeable 1/4" and 3/8" Square Drive Push Through 1/2" Square Drive

**Efficient to use.** Minimises the time to complete the task as these wrenches are quick and easy to adjust due to the clear scale design and simple to use locking mechanism

**Long tool life.** High quality, robust design and construction, further guaranteed by a two year warranty

**Socket choice.** See page 87

**Versatility.** Versatile tools ideal for Maintenance & Repair applications where a range of torques can be applied quickly and easily to a variety of fasteners and connectors



Interchangeable 1/4" and 3/8" Square Drive

Push Through 1/2" Square Drive

Order Code	Drive
024000	1/4"
024010	3/8"
024020	1/2"

Order Code	Model	Calibrated Range			Drive	k	mm	kg	Accuracy	ISO6789 Class
		ISO	Imperial	Imperial						
2201429	Torcofix 5 K	1-5 N.m	0.25 N.m	0.75-3.7 lbf.ft	1/4"	224	0.32	+/- 4%	2A	
1545132	Torcofix 25 K	5-25 N.m	1 N.m	3.7-18 lbf.ft	1/4"	285	0.45	+/- 4%	2A	
1545140	Torcofix 50 K	10-50 N.m	2.5 N.m	7.5-37 lbf.ft	3/8"	335	0.54	+/- 4%	2A	
7601530	Torcofix 100 K	20-100 N.m	5 N.m	15-75 lbf.ft	1/2"	394	0.90	+/- 4%	2A	
7601610	Torcofix 200 K	40-200 N.m	10 N.m	30-150 lbf.ft	1/2"	485	1.10	+/- 4%	2A	
7601880	Torcofix 300 K	60-300 N.m	10 N.m	45-220 lbf.ft	1/2"	577	1.40	+/- 4%	2A	
7674330	Torcofix 400 K	80-400 N.m	10 N.m	60-300 lbf.ft	3/4"	686	2.00	+/- 4%	2A	
7674760	Torcofix 550 K	110-550 N.m	10 N.m	80-405 lbf.ft	3/4"	957	3.80	+/- 4%	2A	
1521365	Torcofix 750 K	150-750 N.m	10 N.m	110-550 lbf.ft	3/4"	1236	4.80	+/- 4%	2A	



# Torcofix Adjustable Clicker Torque Wrenches

Torque range from 5 to 400 N.m

Adjustable general tools for Service and Repair. Ideal for covering a wide number of tasks as the operator can adjust them to deliver a broad range of torques.

An audible click informs user that correct torque has been applied. Multiple applications via range of end fittings and ratchets.



**Clicking Mechanism**  
Incorrect tightening is possible

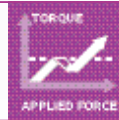

## INDUSTRY SECTORS

Maintenance & Repair



**Audible click provides accuracy and control.** The risk of under and over tightening is reduced, as a click can be heard and felt when the preset torque is reached

**Efficient to use.** Minimises the time to complete the task as these wrenches are quick and easy to adjust due to the clear scale design and simple to use locking mechanism

**Long tool life.** High quality, robust design and construction, further guaranteed by a two year warranty

**End Fittings.** The design allows the use of a range of 16mm spigot, 9x12 end fittings and ratchets for multiple industrial applications.

**See pages 84-86**

**Versatility.** Versatile tools ideal for Maintenance & Repair applications where a range of torques can be applied quickly and easily to a variety of fasteners and connectors

**For more information:** Tool Selector; [gedore-torque.com/tool-selector](http://gedore-torque.com/tool-selector) Telephone; +44 (0) 1483 894 476  
Videos; [www.youtube.com/gedore-torque](http://www.youtube.com/gedore-torque) Email; [salesandrepairs@gedore-torque.com](mailto:salesandrepairs@gedore-torque.com)

Want to know how to use this tool?



Watch our video

Order Code	Model	Calibrated Range			Drive	k	mm	kg	Accuracy	ISO 6789 Class
		ISO	Imperial	Imperial						
1646168	Torcofix 25 Z	5-25 N.m	1 N.m	3.7-18 lbf.ft	16	280	0.50	+/- 4%	2A	
1646176	Torcofix 50 Z	10-50 N.m	2.5 N.m	7.5-37 lbf.ft	16	330	0.60	+/- 4%	2A	
7097270	Torcofix 100 Z	20-100 N.m	5 N.m	15-75 lbf.ft	16	375	0.60	+/- 4%	2A	
7097350	Torcofix 200 Z	40-200 N.m	10 N.m	30-150 lbf.ft	16	465	0.80	+/- 4%	2A	
7097430	Torcofix 300 Z	60-300 N.m	10 N.m	45-220 lbf.ft	16	565	1.20	+/- 4%	2A	
7094090	Torcofix 400 Z	80-400 N.m	10 N.m	60-300 lbf.ft	16	650	1.50	+/- 4%	2A	
1646192	Torcofix 25 SE	5-25 N.m	1 N.m	3.7-18 lbf.ft	9x12	280	0.50	+/- 4%	2A	
1646206	Torcofix 50 SE	10-50 N.m	2.5 N.m	7.5-37 lbf.ft	9x12	330	0.60	+/- 4%	2A	
7600210	Torcofix 100 SE	20-100 N.m	5 N.m	15-75 lbf.ft	9x12	375	0.60	+/- 4%	2A	
7600990	Torcofix 200 SE	40-200 N.m	10 N.m	30-150 lbf.ft	14x18	465	0.80	+/- 4%	2A	
7601020	Torcofix 300 SE	60-300 N.m	10 N.m	45-220 lbf.ft	14x18	565	1.20	+/- 4%	2A	
7604120	Torcofix 400 SE	80-400 N.m	10 N.m	60-300 lbf.ft	14x18	650	1.50	+/- 4%	2A	

## Industrial Adjustable Breaking Torque Wrenches

Torque range from 150 to 1000 N.m

The new Gedore Torque range of industrial torque wrenches has been designed and precision-engineered to meet the needs of the most demanding industries and the toughest working conditions. This includes the automotive, bus and truck, chemical, energy and nuclear industries, as well as major construction and engineering projects.

All these industries require absolute accuracy and precision, supported by robust construction that will survive the toughest working conditions. Our industrial torque wrenches can be used for applications from assembly and manufacture to maintenance, repair and service.

### Absolute accuracy, adjustable torque

These robust tools reduce the chance of over and under tightening, because of the unique Breaking Mechanism: hence their description as 'Breaking Torque Wrenches'. When the preset torque value is reached, these tools break at a specific point along their length. This gives a clear signal – which can be both seen and felt – to the operator that the correct level of torque has been applied and allows time for appropriate operator reaction.

Adjustability is provided by calibrated scales that allow the user to adjust the tool to their desired torque setting, enabling a range of different torque settings to be applied. This makes them suitable for a number of applications, or for applications that require more than one torque value.

At any setting, these tools are guaranteed to deliver the correct torque every time, with absolute and repeatable accuracy. Accurate results to +/- 4 can be expected, in even the toughest working conditions.



# BIW Industrial Breaking Torque Wrenches

## BIW 700, 800, 1000

### Accuracy, consistency and control.

These tools will function to the most stringent and exacting requirements, even in the toughest conditions, because of their robust construction. Accurate process control is ensured by reducing the risk of under and over tightening, due to unique Breaking Technology

**Calibrated scale.** A visible micrometer style scale allows the user to adjust the tool quickly and easily to their desired torque setting, enabling a range of different torque settings to be applied. Dual scaled N.m and lbf.ft

**Durable.** High quality, durable and robust design, construction and materials ensure absolute accuracy, continuity of use and a long tool life in the toughest conditions, hence minimising tool replacement and downtime costs. All-steel construction and corrosion-resistant finish

**Ease of use.** Tools can be used with confidence by operators at any skill level, due to the unique Breaking Technology

**Process Control.** Reduces the likelihood of warranty and rework by assuring process control through accurate and repeatable torque application

**Tested.** These tools are tested to the requirements of ISO 6789 and are supplied with a calibration certificate and storage case

**Versatile.** A range of different torque settings can be applied, making these tools suitable for a number of applications



Industrial Wrench

**For more information:** Tool Selector; [gedore-torque.com/tool-selector](http://gedore-torque.com/tool-selector) Telephone; +44 (0) 1483 894 476 Videos; [www.youtube.com/gedore-torque](http://www.youtube.com/gedore-torque) Email; [salesandrepairs@gedore-torque.com](mailto:salesandrepairs@gedore-torque.com)

Want to know how to use this tool?  
  
 Watch our video

Order Code	Model	Range		k mm LxWxH	Output Drive	Repeatability	ISO 6789 Class
		N.m	Ft.lb				
<b>3022854</b>	BIW 700	150-700 N.m	100-500 Ft.lb	1250 x 100 x 60	$\frac{7}{16}$ "	+/- 4%	2F
<b>3022862</b>	BIW 800	200-800 N.m	150-600 Ft.lb	1250 x 100 x 60	$\frac{7}{16}$ "	+/- 4%	2F
<b>3022870</b>	BIW 1000	300-1000 N.m	200-750 Ft.lb	1470 x 100 x 60	$\frac{7}{16}$ "	+/- 4%	2F



## Weld Stud Test Tools

Torque range from 0.4 to 20 N.m

Weld Stud Test Tools are used during the production of sheet metal products. They are designed for a quick and easy controlled test of the strength and integrity

of welds holding threaded welding studs onto sheet metal. They are most often used for Quality Control in the automotive and appliance industries.

### Breaking Mechanism

Incorrect tightening is unlikely



WSTT 20

WSTT 10

### INDUSTRY SECTORS

Quality Control



Automotive



Aerospace



Electronics



Consumer Products

# Weld Stud Test Tools

## WSTT 2, 10 & 20

**Audit.** These versatile Quality Audit tools enable Quick Go/No Go tests for weld stud integrity to be carried out quickly and efficiently on a wide range of weld studs from M2.5 to M12

**Accuracy.** The risk of damage to the fastener is greatly reduced, due to the unique breaking technology

**Easy and effective to use.** Intuitive & bi-directional "T" shaped handle for easy operation

**End Fittings.** A range of Interchangeable end fittings are available. End fittings are available for use with most popular weld stud thread sizes and lengths

**Long tool life.** High quality, robust design and construction, further guaranteed by a two year warranty

**Versatility.** A range of compatible interchangeable End Fittings are available, for use with most popular weld stud thread sizes and lengths. **See pages 84-86 for details**

### Additional features

All WSTT Tools are supplied with a Calibration Certificate when ordered with an attached end fitting

These Wrenches are preset type torque tools. There is no external adjustment scale and they must be set to the required torque value by using a Torque Analyser. **See page 73 & 77 for details**

Calibration Adaptor (Order Code A25880) is compatible with all WSTT models



## Typical Maximum Torque Test Values (Capacitor discharge method)

Threaded Stud	Steel 4.8 Weldable	Stainless Steel 1.403/03 (A2-50)	Aluminium Alloy AlMg3 F23	Copper CuZn37 (Ms63)
M3	1.2 N.m	0.75 N.m	0.6 N.m	0.9 N.m
M4	2.7 N.m	1.4 N.m	1.3 N.m	1.9 N.m
M5	5.4 N.m	3.5 N.m	2.9 N.m	4.0 N.m
M6	9.2 N.m	5.7 N.m	4.6 N.m	6.75 N.m
M8	12.0 N.m	14.0 N.m	11.25 N.m	16.5 N.m
M10	18.0 N.m	20.0 N.m	-	-

NOTE: These torque values are for guidance only. The torque for each application should be calculated and proven by practical test.

Order Code	Model	Calibrated Range		k mm	g
		ISO	Imperial		
055005	WSTT 2	0.4-2 N.m	3.5-18 lbf.in	120	215
055000	WSTT 10	1-10 N.m	9-90 lbf.in	120	215
055010	WSTT 20	4-20 N.m	35-180 lbf.in	220	320

## Metric or Imperial range of End Fittings available

Metric			
Order Code WSTT 10	Weld Stud Thread x Maximum Length	Order Code WSTT 20	Weld Stud Thread x Maximum Length
055020	M2.5 x 25	055050	M5 x 50
055025	M3 x 50	055055	M6 x 50
055030	M4 x 50	055060	M8 x 50
055035	M5 x 50	055065	M10 x 75
055040	M6 x 50	055070	M12 x 75
055045	M8 x 50	-	-

Metric			
Order Code WSTT 10	Weld Stud Thread x Maximum Length	Order Code WSTT 20	Weld Stud Thread x Maximum Length
055075	4-40 x 1.5"	055105	10-32 x 2.5"
055080	6-32 x 2"	055110	10-24 x 2.5"
055085	8-32 x 2"	055115	¼-20 x 4"
055090	10-32 x 2.5"	055120	5/16-18 x 4"
055095	10-24 x 2.5"	055125	3/8-16 x 4"
055100	¼-20 x 4"	-	-



RTU

# RTU Dynamic Torque Limiters

Torque range from 0.1 to 14 N.m

RTU Dynamic Torque Limiters allow conventional Hand and Power tools to be easily converted into versatile pre-set Torque Tools, giving reliable torque limited fastening to joints. Rotary Torque Units (RTUs) provide a wide range of potential

applications where conventional torque screwdrivers or wrenches might not be appropriate. They are particularly well-suited for maintenance and repair use in manufacturing industries, as they guarantee absolute accuracy and repeatability.

## Slipping Mechanism

Incorrect tightening is impossible



## INDUSTRY SECTORS

Maintenance & Repair



Utilities

Manufacturing



Packaging



Automotive



Electronics





# RTU Dynamic Torque Limiters

**Accuracy.** Accurate process control is ensured by eliminating under and over tightening, due to the unique proven Gedore Torque Slipping Technology. Absolute accuracy is delivered time after time

**Ease of use.** Simply install the RTU to the end of a traditional power tool or hand tool, converting it to a torque tool

**Flexibility.** A range of heavy duty torque limiters creates tools that are suitable for just about any occasion – and can be moved if required

**Power, where you need it.** Powered assembly applications can be performed accurately and quickly, including the tightening of bottles, caps and lids

**Versatility.** New higher range RTU gives users the ability to tighten torque up to 14 N.m

**Wide range of applications.** Can be used where conventional torque screwdrivers or wrenches might not be appropriate

## Additional features

Custom designs and higher torque settings are available



RTU 14

RTU 1

**For more information:** Tool Selector; [gedore-torque.com/tool-selector](http://gedore-torque.com/tool-selector) Telephone; +44 (0) 1483 894 476 Videos; [www.youtube.com/gedore-torque](http://www.youtube.com/gedore-torque) Email; [salesandrepairs@gedore-torque.com](mailto:salesandrepairs@gedore-torque.com)

Want to know how to use this tool?



Watch our video

Order Code	Model	Range		Speed	Input Drive	Output Drive	Repeatability	ISO 6789 Class
		N.m	lbf.in					
019100	RTU 1	0.1-1 N.m	lbf.in 0.9-8.8	0-500RPM	$\frac{9}{16}$ $\frac{1}{2}$	$\frac{1}{2}$ $\frac{1}{4}$	+/- 6%	2F
019200	RTU 4	0.6-4.5 N.m	lbf.in 5.5-39.8	0-500RPM	$\frac{9}{16}$ $\frac{1}{2}$	$\frac{1}{2}$ $\frac{1}{4}$	+/- 6%	2F
019400	RTU 14	2-14 N.m	lbf.in 18-123.8	0-250RPM	$\frac{9}{16}$ $\frac{1}{2}$	$\frac{1}{2}$ $\frac{1}{4}$	+/- 6%	2F

# The new Torque Multiplier

## More features, more innovation, more torque

New for 2017, the Torque Multiplier product range continues our proud 80 year tradition of engineering excellence and customer focus. Building on the success of the Torque Multipliers produced by the Gedore Group for the past 40 years, the new products set new standards for what can be expected from torque tools.

At Gedore, we are committed to design and manufacturing innovation. That's why we believe that the new Torque Multiplier range is a worthy addition to the world's most advanced range of torque tools.

## Helping your business to achieve more

A Torque Multiplier enables a single torque wrench to achieve a wider range of torque output, accurately and consistently. As a result, every torque wrench has the potential to be more versatile and more productive.

For users, this has a whole host of benefits. A single tool can now be used for a wider range of applications, fewer tools need to be carried around, smaller torque tools can be used in confined spaces and lighter tools can be used in difficult working conditions.

For your business, this all adds up to reduced inventory costs and increased speed and productivity.

## Design and manufacturing innovation

**Lighter housing and gear unit.** The housing is 30% lighter than other torque multipliers, but is just as robust and durable. The new ceramic-Teflon® coating enables minimum device lubrication which means that, unlike conventionally lubricated torque multipliers, there is no decrease in performance when outside temperatures are colder.

**Non-destructive overload protection.** 40-550RS models are equipped with a patented non-destructive overload safety mechanism. The basis of this extra feature is a highly-dynamic, pre-tensioned slip-coupling which triggers with a clearly audible acoustic noise as soon as the maximum permissible input torque is exceeded.

**Certified safety.** Every torque multiplier is supplied with a calibration certificate. This guarantees absolute accuracy and enables bolting operations to be implemented at a high level of torque precision.

## Improved reaction arm delivers improved performance

All our torque multipliers are fitted with a reaction arm made of light chrome vanadium steel alloy, which is fitted with an adjustable locking knob with a moveable square end. The purpose of this is to improve performance by absorbing the stress built up in the gear while the bolt is tightened. Without this feature, the tilting movement caused by reaction to use of the multiplier would reduce the maximum permitted torque by 20%. The reaction arm uses a new shape and materials, making it more stable and durable than other torque multipliers. It is equipped with a patented hold function that prevents the gear teeth from slipping.





# Multiplier

## The Torque Multiplier

LKV Series, 500 - 54,000 N.m

The new Gedore Torque LKV series of Torque Multipliers enables your existing torque wrenches to deliver a much wider range of torque output, accurately and consistently. With an LKV Torque Multiplier, a single torque tool can be used for a greater number of applications. For the user, this means greater flexibility, fewer tools to carry around, and enhanced capabilities

from smaller and lighter tools, for confined or difficult working conditions. For your business, this means increased efficiency and reduced inventory costs.

The LKV series of Torque Multipliers sets new standards for design, innovation and quality. These add up to industry-leading performance, reliability and flexibility.

Series LKV-40 550RS



### INDUSTRY SECTORS



Aerospace



Military



Utilities



Automotive



Oil & Gas

# Torque Multiplier LKV-40 to 550RS

**Accuracy and consistency.** Built to a high standard of precision, to ensure that your torque tools operate to their full capabilities

**Calibration certificate.** Supplied with individual Gedore calibration certificate, guaranteeing accuracy and performance

**Ease of use.** Can be used with confidence by operators at any skill level. Easy and quick to assemble. Clear output calculations. Low operator input results in higher output

**Flexibility and versatility.** Existing tools can be used for additional applications, meaning enhanced capabilities, reduced inventory costs and increased productivity. Lighter or smaller tools can be used when working in confined spaces and difficult working conditions

**Improved reaction arm.** Drop-forged reaction arm with lock on function, made of light chrome vanadium steel alloy for increased durability, stability and performance



**Lightweight.** Lean, high-performance aluminium housing is 30% lighter than standard steel housing. This improves operator comfort and ease of use

**Overload safety.** An integrated overload safety mechanism protects the gear unit, by ensuring that the square drive has a pre-determined breaking point. The square shears if overloaded and is easily replaced

**Production efficiency.** Increased speed and productivity are achieved by the use of existing torque wrenches. Decreased bolting time prevents tightening failure and associated costs. A high level of torque is achieved from a low level of input

**Return safety.** Integrated return safety for CW/CCW rotation and safe operation

**Temperature-resistant.** Planet gear unit with ceramic-Teflon®-coated tooth flanks enables minimum device lubrication, meaning that there is no decrease in performance when outside temperatures are colder. This also means that the tool can be stored in a vehicle in a stable transport case



Order Code	Model	N-m max	lbfft max	N-m min/ max	lbfft min/ max	Ratio	Q	Drive	Ø D mm	H mm	kg
2653087	LKV-40	300	220	500-4000	400-2930	1:16	1/2	1	88	212.8	3.9
2653109	LKV-40RS	310	230	500-4000	400-2930	1:16	1/2	1	88	226.9	4.2
2653117	LKV-60RS	400	300	650-6000	500-4400	1:18	3/4	1 1/2	102	256.2	6.6
2653125	LKV-80RS	420	310	800-8000	600-5870	1:22	3/4	1 1/2	128	276.5	9.1
2653133	LKV-100RS	410	305	1000-10000	700-7330	1:28.5	3/4	1 1/2	142	291.5	10.9
2653141	LKV-120RS	380	280	1320-13000	1000-9530	1:39	3/4	1 1/2	174.5	306	17.0
2653168	LKV-550RS	380	280	5500-54000	4000-40330	1:175	3/4	2 1/2	270	414.5	64.6



## The Torque Multiplier

### LKV Series 12, 50 - 1,300 N.m

The new Gedore LKV12 series is the smallest Torque Multiplier in our range and can fit into a pocket. Despite its size, this lightweight and rugged tool enables existing torque wrenches to deliver a wider range of torque output, accurately and consistently.

With an LKV12 Torque Multiplier, a single torque tool can be used for a greater number of applications. For the user, this means greater flexibility, fewer tools to carry around and enhanced capabilities from smaller and lighter tools, for confined or difficult working conditions. For your business, this means increased efficiency and reduced inventory costs. The LKV series of Torque Multipliers sets new standards for design, innovation and quality. These add up to industry-leading performance, reliability and flexibility

The LKV12 is particularly suited for use in workshops, for maintenance and as an on-board tool in utility or construction site vehicles.

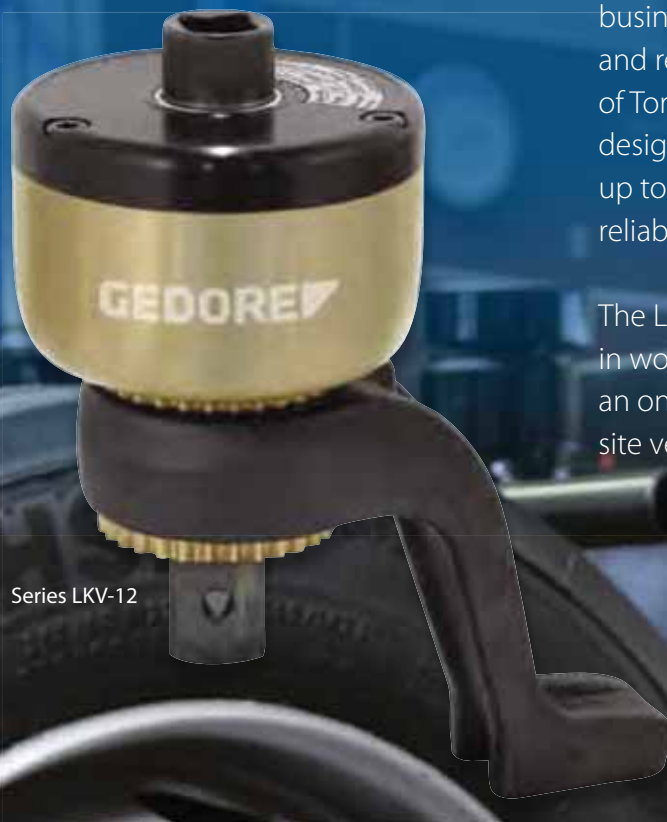

Series LKV-12

#### INDUSTRY SECTORS



Aerospace



Military



Utilities



Automotive



Oil & Gas





**Accuracy and consistency.** Built to a high standard of precision, to ensure that your torque tools operate to their full capabilities

**Calibration certificate.** Supplied with individual Gedore calibration certificate, guaranteeing accuracy and performance

**Ease of use.** Small, lightweight and portable. Can be used with confidence by operators at any skill level. Easy and quick to assemble. Clear output calculations. Low operator input results in higher output

**Flexibility and versatility.** Existing tools can be used for additional applications, meaning enhanced capabilities, reduced inventory costs and increased productivity. Valuable when working in confined spaces and difficult working conditions, because of its small size plus the ability to use lighter and smaller torque tools

**Improved reaction arm.** Drop-forged reaction arm with lock on function, made of light chrome vanadium steel alloy for durability, stability and performance. It is equipped with an offset reaction arm and can be retrofitted with a straight reaction arm

**Lightweight.** Not only is the unit small, but it also uses lean, high-performance aluminium housing which is 30% lighter than standard steel housing. This improves operator comfort and ease of use. The total weight of 1.9 kg delivers the best torque-weight ratio available

**Production efficiency.** Increased speed and productivity are achieved by the use of existing torque wrenches. Decreased bolting time prevents tightening failure and associated costs. A high level of torque is achieved from a low level of input

**Overload safety.** An integrated overload safety mechanism protects the gear unit, by ensuring that the square drive has a pre-determined breaking point. The square shears if overloaded and is easily replaced

**Return safety.** Integrated return safety for CW/CCW rotation and safe operation

**Temperature-resistant.** Planet gear unit with ceramic-Teflon®-coated tooth flanks enables minimum device lubrication, meaning that there is no decrease in performance when outside temperatures are colder. This also means that the tool can be stored in a vehicle in a stable transport case

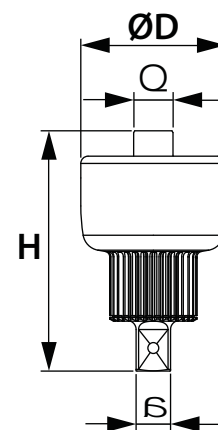

**For more information:** Tool Selector; [gedore-torque.com/tool-selector](http://gedore-torque.com/tool-selector) Telephone; +44 (0) 1483 894 476  
Videos; [www.youtube.com/gedore-torque](http://www.youtube.com/gedore-torque) Email; [salesandrepairs@gedore-torque.com](mailto:salesandrepairs@gedore-torque.com)

Want to know how to use this tool?  
**YouTube**  
Watch our video

Order Code	Model	N-m max	lbf·ft max	N-m min/ max	lbf·ft min/ max	Ratio	Q	Drive	Ø D mm	H mm	kg
2653370	LKV-12	270	200	50-1300	40-950	1:5	1/2	3/4	80	132.5	1.3

# Multiplier

## The Torque Multiplier

LKV Series 20Z / 28Z, 100 - 2,800 N.m

The new Gedore Torque LKV 20Z – 28Z series of Torque Multipliers enables your existing torque wrenches to deliver a much wider range of torque output, accurately and consistently. With an LKV Torque Multiplier, a single torque tool can be used for a greater number of applications. For the user, this means greater flexibility, fewer tools to carry around and enhanced capabilities from smaller and lighter tools, for confined or difficult working conditions.

For your business, this means increased efficiency and reduced inventory costs.

These tools are particularly well-suited for flange bolt connections, where the positioning of the torque multiplier must be implemented easily and rapidly. The LKV-20Z/28Z is equipped with a fixed straight reaction arm and is therefore a complete solution for flange bolt connections. The required spacing between two bolts can be rapidly and easily set using the adjustable reaction square, hence accelerating work.

Series LKV-20Z/28Z



The LKV-Z series is particularly suitable for mechanical and plant engineering, maintenance and the transport industry.

### INDUSTRY SECTORS



Aerospace



Military



Utilities



Automotive



Oil & Gas



**Accuracy and consistency.** Built to a high standard of precision, to ensure that your torque tools operate to their full capabilities

**Calibration certificate.** Supplied with individual GEDORE calibration certificate, guaranteeing accuracy and performance

**Ease of use.** Can be used with confidence by operators at any skill level. Easy and quick to assemble. Clear output calculations. Low operator input results in higher output

**Flange bolt connections.** Particularly well-suited for flange bolt connections, as the reaction arm and adjustable output square enable rapid positioning of the torque multiplier

**Flexibility and versatility.** Existing tools can be used for additional tasks, meaning enhanced capabilities, reduced inventory costs and increased productivity. Valuable when working in confined spaces and difficult working conditions, because of the ability to use lighter and smaller torque tools

**Improved reaction arm.** Drop-forged reaction arm with lock on function, made of chrome-vanadium steel for durability, stability and performance. This is cranked and fixed to the tool

**Lightweight.** Lean, high-performance aluminium housing is 30% lighter than standard steel housing. This improves operator comfort and ease of use

**Production efficiency.** Increased speed and productivity can be achieved, using existing torque wrenches. Decreased bolting time prevents tightening failure. High level of torque from low level of input

**Overload safety.** An integrated overload safety mechanism protects the gear unit, by ensuring that the square drive has a pre-determined breaking point. The square shears if overloaded and is easily replaced

**Return safety.** Integrated return safety for CW/CCW rotation and safe operation

**Temperature-resistant.** Planet gear unit with ceramic-Teflon®-coated tooth flanks enables minimum device lubrication, meaning that there is no decrease in performance when outside temperatures are colder. This also means that the tool can be stored in a vehicle in a stable transport case

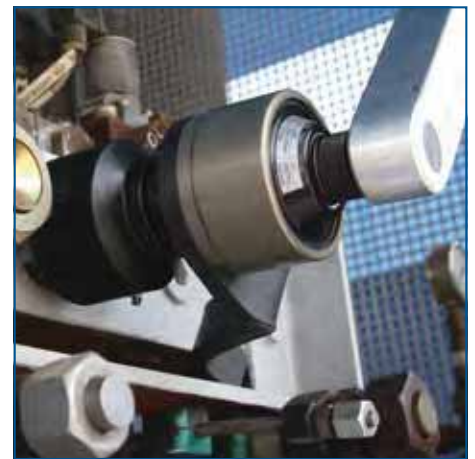

Series LKV-20L/28L

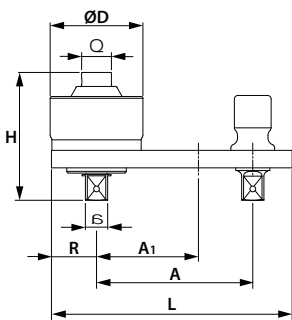

LKV-L

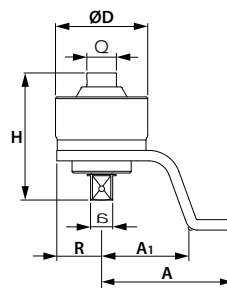

LKV-Z

**For more information:** Tool Selector; [gedore-torque.com/tool-selector](http://gedore-torque.com/tool-selector) Telephone; +44 (0) 1483 894 476  
Videos; [www.youtube.com/gedore-torque](http://www.youtube.com/gedore-torque) Email; [salesandrepairs@gedore-torque.com](mailto:salesandrepairs@gedore-torque.com)

Want to know how to use this tool?  
**YouTube**  
Watch our video

Order Code	Model	N·m max	lb·ft max	N·m min/max	lb·ft min/max	Ratio	Drive	Drive	A mm	A mm	Ø D mm	H mm	R mm	kg
2653249	LKV-20L	580	430	100-2000	70-1500	1:4	3/4"	1"	152	73	88	131	43	1.8
2653265	LKV-20Z	580	430	100-2000	70-1500	1:4	3/4"	1"	150	100	88	131	43	1.8
2653257	LKV-28L	550	410	500-2800	400-2050	1:5.5	3/4"	1"	199	83	106	146	52	2.4
2653273	LKV-28Z	550	410	500-2800	400-2050	1:5.5	3/4"	1"	151	101	106	146	52	2.4



## The Cordless Torque Wrench

LDA/LAW Series, 90 - 6,000 N.m

The new Gedore high-torque cordless torque wrench delivers accurate torque, wherever you need it. This powerful tool is capable of generating precise torque up to 6,000 N.m, without slip coupling and impact mechanism. The powerful lithium ion battery means that the tool can be used

independently and flexibly at great heights or in confined spaces. Once the battery is fully discharged, you can switch to electrical operation with the optional hybrid set. The Gedore Cordless Torque Wrench is available as a straight (LDA series) or angled (LAW series) version.



LDA series



Hybrid set option available

### INDUSTRY SECTORS



Aerospace



Military



Utilities



Automotive



Oil & Gas



LAW series

**Accuracy and consistency.** Built to a high standard of precision, to ensure accurate torque application, every time, reducing the risk of over or under tightening

**Batteries that run for longer.** The powerful lithium ion batteries operate for twice as long as nickel-cadmium batteries. What's more, they operate with uniform peak performance until they are fully discharged

**Easy and safe to use.** The soft-grip of the motor unit sits comfortably in the hand, non-slip and fatigue-free, due to the gear centre of gravity. The battery can be inserted from two sides. The braked 360°-rotating drive unit prevents any injuries to the operator when used in confined spaces

**Power with precision.** Patented microprocessor electronics increase and regulate the battery voltage.

This increases the running time of the battery and maintains the torque at a constant level. This allows the tightening torque for each bolting operation to be precisely maintained and ensures stable torque accuracy over the entire discharging cycle of the battery

**Protection and safety.** The microprocessor prevents gear damage when loosening hard bolted connections. An active release function ensures that the wrench automatically releases after work is complete

**Standard accessories.** The LDA and LAW series both come complete with a machine reaction arm cranked, two lithium ion batteries, a battery charger, tool case, operating manual and factory calibration certificate

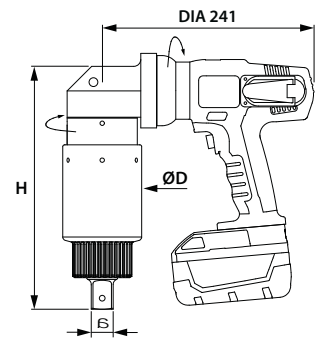

LAW series – angled version

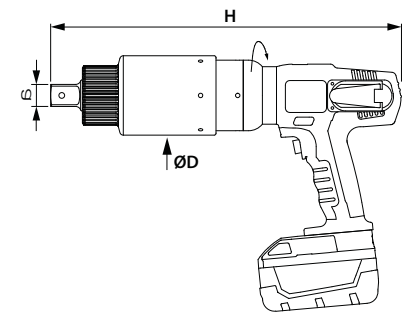

LDA series – straight version

Order Code	Model	N-m min/ max	lb-ft min/ max	Max RPM	Drive	Ø D mm	H mm	kg
19100.000	LDA - 05	90-500	70-370	48	3/4"	80	308	4.2
19140.000	LDA - 07	120-700	90-520	27	3/4"	80	342	4.7
19190.000	LDA - 09ST	130-900	100-670	24	3/4"	80	342	4.7
19250.000	LDA - 15	180-1500	110-1110	20	1"	88	357	5.9
19350.000	LDA - 16ST	250-2100	180-1550	9	1"	90	375	6.5
19450.000	LDA - 28ST	350-3100	260-2290	7	1"	90	398	7.2
19500.001	LDA - 40	430-4000	320-2950	5	1"	94	398	7.5
19550.000	LDA - 60	650-6000	480-4430	4	1 1/2"	102	412	8.7
19191.000	LAW - 09ST	130-900	100-670	24	3/4"	80	220	5.9
19351.000	LAW - 16ST	250-2100	180-1550	9	1"	90	254	7.5
19451.000	LAW - 28ST	350-3000	260-2200	7	1"	90	277	8.3
19501.000	LAW - 40	430-4000	320-2950	5	1"	94	277	8.5



# Torque Calibration

## Introduction

This section covers the comprehensive range of Torque Calibration equipment manufactured by Gedore Torque.

Torque calibration equipment is used for the testing, calibration and recalibration of Torque Tools. This ensures that torque equipment operates to peak performance and guarantees absolute and consistent accuracy and adherence to national and international standards.

It also ensures that potential tooling problems are identified before they arise, ensuring that lifetime ownership costs are minimised.

Torque Calibration equipment is also used to predict the behaviour of fasteners and to recommend optimum torque.

As an alternative to purchasing calibration equipment, the Gedore Torque service centre offers a wide range of Calibration Services. These can be carried out at our UKAS accredited Calibration Laboratory.



## Torque Calibration Analysers

Torque Calibration equipment is based upon Torque Calibration Analysers, of which there are two basic types: Electronic and Mechanical.

### Electronic Torque Calibration Analysers

Our modern range of Digital Torque Calibration Equipment is highly accurate, reliable and easy to use. It enables the user to download test results, test power tools, select different units of measurement and carry out calibration beyond the scope of mechanical calibration devices.

### Mechanical Torque Calibration Analysers

Mechanical Torque Analysers offers the user a low cost, robust and easy to use device, that's designed to set and calibrate low range torque tools. These Analysers will give many years of accurate and reliable service.

## Functions of Torque Calibration Analysers

This chart summarises the functions of the various Torque Calibration Analysers. Further details are on the following pages.

Torque Calibration Analysers	Screwdriver Testing	Wrench Testing	Powered Tool Testing	Memory Capability	PC Download Capability	Interchangeable Sensors
CAPTURE System	☒	☒	☒	☒	☒	☒
CAPTURE Hub	☒	☒	☒	☒	☒	☒
MTP	☒	-	-	-	-	-
MTS	☒	☒	-	-	-	-
DREMOTEST E	☒	☒	-	-	☒	-

## CAPTURE Display

This intuitive easy to use Display can be integrated with your existing Sensors. This enables you to benefit from the industry-leading CAPTURE system, whilst minimising investment.

**Cost-effective.** Minimise investment, as the CAPTURE Display is designed to integrate with customers' existing industry standard nominal 2mV/V Sensors

**Carry Case included.** To protect the CAPTURE Display when not in use it is supplied complete in a high impact plastic carry case

**Ease of use.** Designed to allow users to become productive quickly due to its intuitive features, such as easy to navigate menus, tool database and Plug & Play integration with CAPTURE Sensors

**Fully Inclusive.** The following items are included with the Display and are stored in the Carry Case - USB Power Cable (for charging from Mains or PC and also used for data transfer), Power Supply (multi-national), Calibration Certificate, Start Up Guide and Instructions

**Long Life Battery.** Work for longer between battery charges as the unit is fitted with a long life Lithium-ion battery and has an auto power down mode

**Memory.** CAPTURE Display can store 500 tools and 2000 data readings in the onboard memory

**Versatility.** Design allows static laboratory use and mobile data collection using an onboard memory and rechargeable battery. The data can then be transferred to PC via USB connection



CAPTURE Display



CAPTURE Manager

Order Code	Model
<b>038700</b>	CAPTURE Display
<b>038710</b>	CAPTURE Manager - PC Software
<b>038703</b>	CAPTURE Display - 4 Way Switch
<b>036226</b>	CAPTURE Cable - CAPTURE Display to Custom Sensor
<b>036246</b>	CAPTURE Cable - CAPTURE Display to CAPTURE Sensor
<b>036251</b>	CAPTURE Cable - CAPTURE Display to SDX Screwdriver
<b>036256</b>	CAPTURE Cable - CAPTURE Display to ETX Wrench

# CAPTURE Sensor

## Torque Range from 0.1 to 1500 N.m

The CAPTURE Sensor is part of the industry-leading CAPTURE system, providing highly accurate torque measurement for Hand and Power Torque Tools.

CAPTURE Sensor CS 10



CAPTURE Sensor with optional rundown fixture

Order Code	Model
<b>038771</b>	CAPTURE Sensor ISO 1500/90° Adaptor
<b>D18205</b>	CAPTURE Sensor ISO-A Mount
<b>038772</b>	CAPTURE Sensor Quick Change Plate

Calibrated range: 10% to 100% of capacity

**Carry Case.** To protect the Sensor when not in use it is supplied in a high impact plastic carry case

**Flexible.** Built-in flexibility as the sensor can be mounted horizontally or vertically without the need for any accessories

**Ease of Use.** Fast to set up when used with a CAPTURE Display due to the imbedded Quicktec technology that passes all the Sensor information to the Display

**Optional Torque Loading System.** Remove human error from testing by using the CAPTURE Sensor with the ISO 1500/90° Torque Loading System (**Adaptor required – see page 79**)

**Quick Change Plate.** For users with limited space who need to change Sensors between tests the Quick Change Plate increases calibration productivity

**UKAS Certification.** Sensors come complete with a UKAS certificate to BS 7882: class 1 or better

Order Code	Model	Range	Drive	k mm H x W x D	kg	Hole Centres (mm)	Mounting Hole Size	Fixings Supplied	
<b>038802</b>	CS 1.5	0.1-1.5 N.m	$\frac{1}{4}$	62 x 85 x 65	0.50	56	M8 x 1.25 (10 Deep Min)	M8 x 50 *	<b>P34320</b>
<b>038805</b>	CS 2	0.2-2 N.m	$\frac{1}{4}$	62 x 85 x 65	0.50	56	M8 x 1.25 (10 Deep Min)	M8 x 50 *	<b>P34320</b>
<b>037110</b>	RF 2 Rundown	0.2-2 N.m	$\frac{1}{4}$	–	0.50	–	–	M4 x 8	<b>P15900</b>
<b>038807</b>	CS 5	0.5-5 N.m	$\frac{1}{4}$	62 x 85 x 65	0.50	56	M8 x 1.25 (10 Deep Min)	M8 x 50 *	<b>P34320</b>
<b>037120</b>	RF 5 Rundown	0.5-5 N.m	$\frac{1}{4}$	–	0.50	–	–	M4 x 8	<b>P15900</b>
<b>038810</b>	CS 10	1-10 N.m	$\frac{1}{4}$	62 x 85 x 65	0.50	56	M8 x 1.25 (10 Deep Min)	M8 x 50 *	<b>P34320</b>
<b>038815</b>	CS 25	2.5-25 N.m	$\frac{3}{8}$	62 x 85 x 65	0.50	56	M8 x 1.25 (10 Deep Min)	M8 x 50 *	<b>P34320</b>
<b>037130</b>	RF 25 Rundown	2.5-25 N.m	$\frac{1}{2}$	–	0.50	–	–	M4 x 8	<b>P15900</b>
<b>038820</b>	CS 50	5-50 N.m	$\frac{3}{8}$	62 x 85 x 65	0.57	56	M8 x 1.25 (10 Deep Min)	M8 x 50 *	<b>P34320</b>
<b>038825</b>	CS 100	10-100 N.m	$\frac{1}{2}$	62 x 85 x 65	0.60	56	M8 x 1.25 (10 Deep Min)	M8 x 50 *	<b>P34320</b>
<b>038830</b>	CS 250	25-250 N.m	$\frac{1}{2}$	82 x 120 x 87	1.45	79	M12 x 1.75 (16 Deep Min)	M12 x 1.75 *	<b>P34330</b>
<b>038835</b>	CS 500	50-500 N.m	$\frac{3}{4}$	82 x 120 x 87	1.6	79	M12 x 1.75 (16 Deep Min)	M12 x 1.75 *	<b>P34330</b>
<b>038845</b>	CS 1500	150-1500 N.m	1	100 x 165 x 134	4.00	125	M16 x 2.0 (20 Deep Min)	M16 x 90 *	<b>P34340</b>

\* Socket Cap Head Screw



# CAPTURE Hub

## CAPTURE Hub

The Gedore Torque CAPTURE Hub is the latest addition to the industry-leading Capture range of calibration equipment and is available from 2017. A lineside torque analyser for production power tools, it provides highly accurate measurement

both clockwise or anti clockwise, as well as hand tools if required, and incorporates an integrated Screen and Sensor. It is portable enough to be used as part of a mobile calibration centre and robust enough to be used in a production environment.



## CAPTURE Hub: the latest addition to the Capture range

**Calibrated range.** 10% to 100% of capacity

**Easy to Repair.** Modular design allows for simple component replacement

**Cost-effective.** Minimise investment, as the CAPTURE Hub is designed to be a standalone solution, or to integrate with customers' existing Capture components as well as other industry standard nominal 2mV/V Sensors

**Ease of use.** Intuitive software design is similar to CAPTURE Display allowing existing Capture users to be familiar with the architecture and new users to become productive quickly, with its easy to use menus and Plug & Play functionality

**Flexibility.** The CAPTURE Hub can integrate with CAPTURE Manager PC software (Order Code 038710) and users with extra Sensors can plug them directly into the external port on the side of the CAPTURE Hub. The unit can also be mounted horizontally or vertically to meet the existing setups of customers

**Long Life Battery.** Work for longer between battery charges as the unit is fitted with an improved long life Lithium-ion battery and has a customisable auto power down mode

**Carry Case.** To protect the CAPTURE Hub when not in use it is supplied in a high impact plastic carry case

**Calibration Certificate.** All CAPTURE Hub systems are supplied complete with in house Certificate which is traceable to International Standards. Accuracy +/-1% of reading. UKAS certification is available on request at additional cost

**Versatility.** The design allows static laboratory use and mobile data collection using an on-board memory and rechargeable battery. This means that the system can be used as part of mobile calibration centre and also at the point of use. The data can be transferred to PC via USB connection

**Yet more versatility.** Can be used with Optional Torque Loading System. Remove human error from testing by using the CAPTURE Hub with the ISO-A Loading System (**Adaptor required – see page 79**)

**Tool Storage and memory.** The CAPTURE Hub can store 50 tools and 2000 readings



Rundown fixture

**For more information:** Tool Selector; [gedore-torque.com/tool-selector](http://gedore-torque.com/tool-selector) Telephone; +44 (0) 1483 894 476  
Videos; [www.youtube.com/gedore-torque](http://www.youtube.com/gedore-torque) Email; [salesandrepairs@gedore-torque.com](mailto:salesandrepairs@gedore-torque.com)

Want to know how to use this tool?

**YouTube**

Watch our video

Order Code	Model	Range	Drive	$\begin{matrix} \text{k} & \text{mm} \\ \text{H} \times \text{W} \times \text{D} \end{matrix}$	$\begin{matrix} \text{kg} \\ \text{kg} \end{matrix}$	Hole Centres (mm)
036910	CH 1	0.1-1 N.m	$\frac{1}{4}$	50 x 200 x 110	0.50	56
036920	CH 2	0.2-2 N.m	$\frac{1}{4}$	50 x 200 x 110	0.50	56
037110	RF 2 Rundown	0.2-2 N.m	$\frac{1}{4}$	62 x 93 x 32	0.50	
036930	CH 5	0.5-5 N.m	$\frac{1}{4}$	50 x 200 x 110	0.50	56
037120	RF 5 Rundown	0.5-5 N.m	$\frac{1}{4}$	62 x 78 x 32	0.50	
036940	CH 25	2.5-25 N.m	$\frac{3}{8}$	50 x 200 x 110	0.50	56
037130	RF 25 Rundown	2.5-25 N.m	$\frac{1}{2}$	62 x 120 x 32	0.50	

## CAPTURE Manager

The CAPTURE Manager is PC Software that allows storage, management and analysis of tools and data readings. It is part of the

industry-leading CAPTURE system, providing highly accurate torque measurement for Hand and Power Torque.

**Data management and analysis.**

Manage tool and test data through the CAPTURE Manager PC software. The software also makes analysing the data quick and easy through integration with Microsoft Excel®

**Test Wizard.**

Ensures tools are performing to the required standard through the ISO 6789 test wizard. This clear and easy to use feature guides the user through the test procedure

**Data storage.**

The CAPTURE Manager PC software allows unlimited storage of tools and data readings that can be uploaded and downloaded to the CAPTURE Display via USB connection

**Tool Calibration Certificates.**

Tool traceability can be achieved as the CAPTURE Manager PC software can generate customised calibration certificates to the requirements of ISO 6789



CAPTURE Manager

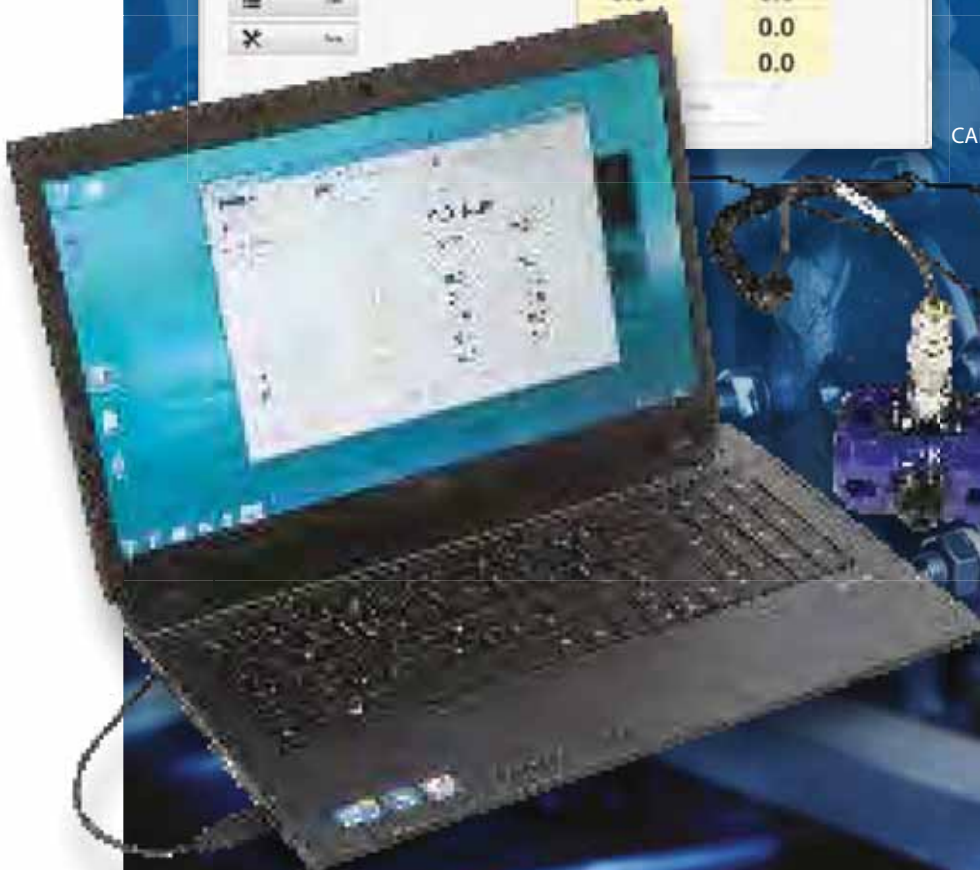

**Order Code**

**038710**

CAPTURE Manager - PC Software



# Rotary Torque Sensors

## Torque range from 0.2 to 1400 N.m

These Sensors provide highly accurate torque measurement for Hand and Power Torque Tools. They can be used in conjunction with our CAPTURE Display or with your current Torque Analyser. Connect between tool and joint, to measure the actual torque being applied from the joint to the fastener.

**Accurate measurement.** These Sensors are designed to ensure your tightening process is within acceptable limits with a high degree of certainty. The Rotary Torque Sensor is the ideal torque-auditing tool for testing the actual torque being applied on the assembly application. By connecting a rotary torque sensor between an electric or pneumatic tool and assembly application, you can monitor the torque being applied from the tool to fastener or bolt

**Inline connection.** Designed to be placed inline with the tooling, they measure the actual torque being applied on the assembly application, accurate to 0.3% of maximum torque applied. By connecting a rotary torque sensor between an electric or pneumatic tool and assembly application, you can monitor the torque being applied from the tool to fastener or bolt

**UKAS certificates.** Rotary Sensors come complete with UKAS certificates to BS7882

**Versatile.** These Sensors are designed to be compatible with most industry standard devices

**Work with most Torque Analysers.** A cost effective solution, as in most cases, there is no need to upgrade



To download detailed Product Card go to [www.gedore-torque.com](http://www.gedore-torque.com)

**For more information:** Tool Selector; [gedore-torque.com/tool-selector](http://gedore-torque.com/tool-selector) Telephone; +44 (0) 1483 894 476 Videos; [www.youtube.com/gedore-torque](http://www.youtube.com/gedore-torque) Email; [salesandrepairs@gedore-torque.com](mailto:salesandrepairs@gedore-torque.com)

Want to know how to use this tool?



Watch our video

Order Code	Model	Calibrated Range		Maximum RPM		Width	Height	Depth	kg
		ISO	Drive	Continuous	Intermittent	mm	mm	mm	
036510	XR 2 HD	0.2-2 N.m	1/2"	5000	11000	116	56.0	68.0	0.21
036520	XR 5 HD	0.5-5 N.m	3/4"	5000	11000	116	56.0	68.0	0.21
036530	XR 20 HD	2-20 N.m	1 1/4"	5000	11000	116	56.0	68.0	0.21
036540	XR 20 SD	2-20 N.m	1/4"	5000	11000	71.5	56.0	71.5	0.20
036550	XR 75 SD	7.5-75 N.m	3/8"	2500	10000	77.0	56.0	74.0	0.24
036560	XR 180 SD	18-180 N.m	1/2"	2500	7600	87.0	58.0	82.5	0.43
036570	XR 500 SD	50-500 N.m	3/4"	2000	5000	106	60.0	93.5	0.78
036580	XR 1400 SD	140-1400 N.m	1"	1000	4400	125	64.5	104	1.50

# Torque Testers

## MTP & MTS Mechanical Torque Testers

Torque range from 0 to 25 N.m

Mechanical Torque Calibration Analysers that can be used in a many different situations to provide accurate measurement of torque values for hand-operated Torque Tools. These testers are portable, robust and do not require power.



# MTP & MTS Mechanical Torque Testers

## MTP 10 & MTS 35, 130, 400, 1200 & 2500

**Accurate measurement.** Designed to monitor low torque values for Hand operated Torque Tools, providing +/-2% accuracy

**Ease of use.** Perfect for use by operators of any skill level, as the robust design eliminates the fear of damage caused by overloading

**Fast results.** The MTS Testers are designed to quickly give confidence that your Torque Tools are operating within limits. The easy to read analogue dial, peak torque and limit pointers all work together to give the operator instant confirmation of tool performance

**Long tool life.** High quality and robust design, with a two year warranty

**End Fittings.** Compatible with Setting adaptors see page 84

**Versatile.** Able to operate in a wide variety of environments and situations from shop floor to field operations as the MTS and MTP have no requirement for power

**Servicing.** Regular servicing is essential to ensure precision and consistent accuracy



MTS 1200

MTP 10

**For more information:** Tool Selector; [gedore-torque.com/tool-selector](http://gedore-torque.com/tool-selector) Telephone; +44 (0) 1483 894 476  
Videos; [www.youtube.com/gedore-torque](http://www.youtube.com/gedore-torque) Email; [salesandrepairs@gedore-torque.com](mailto:salesandrepairs@gedore-torque.com)

Want to know how to use this tool?



Watch our video

Order Code	Model	ISO	Calibrated Range			Drive	kg	Accuracy
			SI	Imperial	SI			
058100	MTP 10	0-10 cN.m	0.5 cN.m	0-14 ozf.in	1 ozf.in	$\frac{1}{8}$	0.98	+/- 2%
058110	MTS 35	7-35 cN.m	0.5 cN.m	10-50 ozf.in	0.5 ozf.in	$\frac{1}{4} + \frac{1}{4}$	3.20	+/- 2%
058120	MTS 130	26-130 cN.m	2 cN.m	36-180 ozf.in	2 ozf.in	$\frac{1}{2} + \frac{1}{4}$	3.20	+/- 2%
058130	MTS 400	0.8-4 N.m	0.05 N.m	7-36 lbf.in	0.5 lbf.in	$\frac{1}{2} + \frac{1}{4}$	3.20	+/- 2%
058140	MTS 1200	2.4-12 N.m	0.2 N.m	24-120 lbf.in	2 lbf.in	$\frac{1}{4} + \frac{9}{8}$	3.20	+/- 2%
058150	MTS 2500	5-25 N.m	0.5 N.m	44-220 lbf.in	5 lbf.in	$\frac{1}{4} + \frac{9}{8}$	3.20	+/- 2%



## DREMOTEST E Torque Calibration Analysers

Torque range from 0.2 to 3000 N.m

Robust, accurate Torque Calibration Analysers that are ideal for Hand Torque Tools covering a wide torque range, in a Workshop or Repair environment.

**Accurate measurement.** Easy to use, robust Torque Calibration Analysers providing +/-1% accuracy

**Data management capability.** A RS 232 output allows data to be exported to Hyper Terminal Software

**Full set of Accessories.** Drive adaptor, mains lead, connectors and Certificate of Calibration all included

**Long Service Life.** Simple lightweight design, backed up by a full Aftersales and Recalibration Service

**Versatility.** Five models available covering a range from 0.2 to 3000 N.m

**Value for money.** A comprehensive package, at a competitive price compared to traditional Mechanical Analysers

DREMOTEST E 55



DREMOTEST E 12



Order Code	Model	Calibrated Range				Resolution	Drive	kg	Accuracy
		ISO	Resolution	Imperial	Resolution				
2288311	DREMOTEST E 12	0.2-12 N.m	0.001 N.m	1.8-106 lbf.in	0.001 lbf.in	$\frac{1}{4} + \frac{1}{4} + \frac{3}{8}$	2.60	+/- 1%	
1947699	DREMOTEST E 55	0.9-55 N.m	0.01 N.m	0.7-40 lbf.ft	0.01 lbf.ft	$\frac{1}{2} + \frac{3}{8}$	2.60	+/- 1%	
1856111	DREMOTEST E 320	9-320 N.m	0.1 N.m	7-236 lbf.ft	0.1 lbf.ft	$\frac{3}{8} + \frac{1}{2}$	2.60	+/- 1%	
1947702	DREMOTEST E 1100	90-1100 N.m	1 N.m	66-811 lbf.ft	1 lbf.ft	$\frac{1}{2} + \frac{3}{4}$	10.0	+/- 1%	
2529858	DREMOTEST E 3000	500-3000 N.m	1 N.m	369-2214 lbf.ft	144 lbf.ft	1	26.0	+/- 1%	

# ISO 1500/90° & ISO-A

## Torque Loading Systems

Versatile Torque Loading Systems that enable precise Torque calibration and testing, up to a surprisingly high level of torque, to be undertaken on your own premises. Accurate and easy to use, the possibility of human error or variation is eliminated.

**Accurate.** These Torque Loading Systems enable the accurate testing of all Torque Wrenches within their given range, whilst removing the possibility of human error or variation

**Adaptable.** An easy adjustment system to suit the individual Torque Wrench being calibrated

**Easy to use.** 1200:1 Gearbox requires low operator effort, therefore torques as high as 1500 N.m can be achieved with ease

**Improved in-house capability.** Torque calibration and testing can be carried out on your own premises, eliminating the need to use external suppliers

**ISO accreditation.** Meets the International Standard ISO 6789 for the calibration of Torque Wrenches



ISO 1500/90° Torque Loading System

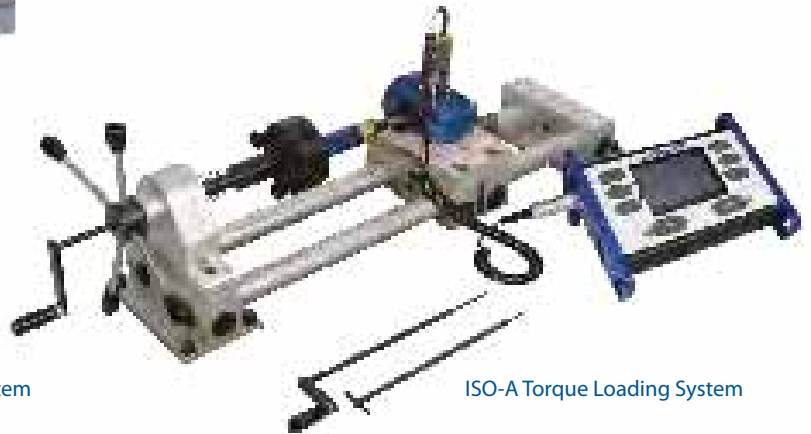

ISO-A Torque Loading System

**For more information:** Tool Selector; [gedore-torque.com/tool-selector](http://gedore-torque.com/tool-selector) Telephone; +44 (0) 1483 894 476  
Videos; [www.youtube.com/gedore-torque](http://www.youtube.com/gedore-torque) Email; [salesandrepairs@gedore-torque.com](mailto:salesandrepairs@gedore-torque.com)

Want to know how to use this tool?



Watch our video

Order Code	Model	Maximum Capacity		Maximum Tool Length	
		ISO	Imperial	mm	kg
<b>014300</b>	ISO 1500/90° Torque Loading System	1500 N.m	1107 lbf.ft	1350	32.0
<b>014400</b>	Torque Master ISO-A Torque Loading System	30 N.m	22 lbf.ft	300	8.75
<b>D18204</b>	E-tp Mounting Kit	30 N.m	22 lbf.ft	300	1.60
<b>D18205</b>	CAPTURE Sensor & CAPTURE Hub ISO-A Mount	30 N.m	22 lbf.ft	300	3.40
<b>038771</b>	CAPTURE Sensor ISO 1500/90° Adaptor	1500 N.m	1107 lbf.ft	–	2.60



## Special Torque Tool Projects

### Introduction

Our 80 years experience and expertise as the leading producer of torque tools mean that we are able to meet the needs of our customers for tools to meet the most exacting and specialised torque applications.

At our UK site, the world's most advanced and fully-integrated torque tool manufacturing facility, we are able to combine innovative expert engineering design skills with our high quality core product range to produce bespoke tools.

For our customers, this means that whatever challenges they are facing, we are able to find cost-effective solutions. For the Royal Navy (see right-hand facing page), we were able to help save money and lives. Your needs may be less dramatic, but we will take them just as seriously.

#### **In this section you will find further information about:**

Custom Tool Kit Designs

Tailor-made Torque Screwdrivers and Wrenches

Private Label Torque Tools





**HMS Illustrious: the power of precision**

*The correct application of torque guarantees the safety, reliability and longer life of products. This was certainly the case when Gedore Torque worked with the Ministry of Defence and the Royal Navy to build a custom tool kit for maintaining lifejackets on ships like the famous aircraft carrier, HMS Illustrious. With more than 1,000 crew and Flight Arm personnel on HMS Illustrious alone, that's a serious task. Said Petty Officer Keith Spiller, responsible for the project, 'At the end of the day, by applying exactly the correct level of torque to the equipment, we're saving lives – and we're also saving money.'*



# Custom Tool Kit Designs

Our Custom Design Service can create a complete Torque Tool Kit, tailor-made to meet your application needs.

**Experience and expertise.** A wide range of Tool Kit needs can be met using our Custom Design Service. This draws upon our experience and expert engineering design skills to produce bespoke tools to meet the most exacting of application needs

**Tool Cases.** To meet operational needs, Tool Kits can be supplied in bespoke tool cases and foam cut outs. These can range from standard design for use in normal working environments to high performance cases for use in harsh operational conditions

**Tool Kit Versatility.** A combination of Gedore Torque and outsourced tools can be created to meet your particular specification



# Custom Torque Tool Designs

Our Custom Design Service can create Torque Tools to meet specific operational needs.

**Experience and expertise.** Our Custom Design Service can design and produce Torque Tools to a customised specification to meet your operational and application needs. This draws upon our experience and expert engineering design skills to produce bespoke tools to meet the most exacting of application needs

**Innovation.** Our track record of torque innovation means that we are able to meet the wide range of performance criteria required from the modern Torque Tool with a range of innovative tool designs and appropriate materials

**Operational Integrity.** Our tried and tested tool designs and technology can be depended upon to produce bespoke successful engineering solutions



Modification of RTU for Track Bolt Tightening

# Private Label Torque Tools

Our Custom Design Service can create a complete Torque Tool Kit, tailor-made to meet your application needs.

**Image enhancement.** As well as enabling you to carry out the best possible job, private label tools can also provide you with a more professional image

**Our tools, your design.** A full Design Service is available for custom label tools that use a variety of materials, component design, tool labelling and custom tool certification

**Technology-aided design.**

Cost-effective own branding has been made easier by the use of our modern 3D CAD Systems, laser engraving machines and custom label manufacturing technology

**Let's Torque.** Use our Tool Selector at [www.gedore-torque.com/tool-selector](http://www.gedore-torque.com/tool-selector) to select the right tool for your application, then tell us your branding requirements on +44 (0) 1483 894 476



Private Label of an Ergo Quickset Adjustable Torque Screwdriver



Private Branding of an ADS Dial Wrench



TSN Wrench Private Branding

Private Label projects are subject to minimum quantities

**For more information:** Tool Selector; [gedore-torque.com/tool-selector](http://gedore-torque.com/tool-selector) Telephone; +44 (0) 1483 894 476  
Videos; [www.youtube.com/gedore-torque](http://www.youtube.com/gedore-torque) Email; [salesandrepairs@gedore-torque.com](mailto:salesandrepairs@gedore-torque.com)

Want to know how  
to use this tool?  
**YouTube**  
Watch our video



# Torque Accessories

## Torque Wrench End Fittings

### Captive Pin Type

Metric & Imperial Accessories compatible with TBN Preset Breaking Torque Wrenches, Models TBN 2 & 10 (see page 38)



←		Metric				→	
A/F	Order code	A/F	Order code	A/F	Order code	A/F	Order code
	Open End		Ring End*		Flared End		Setting Adaptor
3.2	012000	3.2	012250	3.2	-	3.2	012700
4	012005	4	012255	4	-	4	012700
5	012010	5	012260	5	-	5	012700
5.5	012015	5.5	012265	5.5	-	5.5	012700
6	012020	6	012270	6	-	6	012705
7	012025	7	012275	7	-	7	012705
8	012030	8	012280	8	012505	8	012705
9	012035	9	012285	9	012510	9	012705
10	012040	10	012290	10	012515	10	012710
11	012045	11	012295	11	012520	11	012710
12	012050	12	012300	12	012525	12	012710
13	012055	13	012305	13	012530	13	012710
14	012060	14	012310	14	012535	14	012715
15	012065	15	012315	15	012540	15	012715
16	012070	16	012320	16	012545	16	012715
17	012075	17	012325	17	012550	17	012715
18	012080	18	012330	18	-	18	012720
19	012085	19	012335	19	012555	19	012720
20	012090	20	012340	20	-	20	012720
21	012095	21	012345	21	-	21	012720
22	012100	22	012350	22	012560	22	012722
23	012105	23	012355	23	-	23	012722
24	012110	24	012360	24	012565	24	012722
25	012115	25	012365	25	-	25	012722

←		Imperial				→	
A/F	Order code	A/F	Order code	A/F	Order code	A/F	Order code
	Open End		Ring End*		Flared End		Setting Adaptor
5/32	012150	5/32	012400	5/32	-	5/32	012725
3/16	012155	3/16	012405	3/16	-	3/16	012725
7/32	012160	7/32	012410	7/32	-	7/32	012725
1/4	012165	1/4	012415	1/4	012600	1/4	012725
5/16	012175	5/16	012420	5/16	012605	5/16	012730
3/8	012185	3/8	012425	3/8	012610	3/8	012730
7/16	012195	7/16	012430	7/16	012615	7/16	012730
1/2	012200	1/2	012435	1/2	012620	1/2	012730
9/16	012205	9/16	012440	9/16	012625	9/16	012735
5/8	012210	5/8	012445	5/8	012630	5/8	012735
11/16	012215	11/16	012450	11/16	-	11/16	012735
3/4	012220	3/4	012455	3/4	012635	3/4	012735
13/16	012225	13/16	012460	13/16	-	13/16	012740
7/8	012230	7/8	012465	7/8	012640	7/8	012740
15/16	012235	15/16	012470	15/16	-	15/16	012740
1	012240	1	012475	1	012645	1	012740

To convert TBN 2 & 10 to 1/4" Square Drive

Type	Order Code	Centre mm
1/4 Fixed	<b>A36340</b>	27
1/4 Ratchet	<b>A73640</b>	27



### Hex Key Setting Adaptors

Order Code	Hex Key Sizes A/F
<b>A45271</b>	1.0 - 2.5 mm
<b>A45272</b>	3.0 - 5.0 mm
<b>A45273</b>	6.0 - 8.0 mm



### Hex Key Adaptors

Order Code	Hex Key Sizes mm
<b>A37610</b>	1.0 - 2.5 mm
<b>A37620</b>	3.0 - 5.0 mm
<b>A38350</b>	6.0 - 8.0 mm



Blank End  
For making up Specials  
Material 070M20 (EN3B)

Order Code	Centre mm
<b>A64440</b>	12
<b>A64450</b>	34



# Torque Wrench End Fittings

## 8 mm Spigot Type

Metric & Imperial Accessories compatible with ATB Adjustable Breaking Torque Wrenches, Models ATB 2.5, 5 & 10 (see page 47)



Open End



Ring End

\* Ring End supplied as bi-hex or 6pt hex



Flared End

Metric		Metric			
A/F	Order code Open End	A/F	Order code Ring End*	A/F	Order code Flared End
3.2	049000	3.2	049250	3.2	-
4	049005	4	049255	4	-
5	049010	5	049260	5	-
5.5	049015	5.5	049265	5.5	-
6	049020	6	049270	6	-
7	049025	7	049275	7	-
8	049030	8	049280	8	049505
9	049035	9	049285	9	049510
10	049040	10	049290	10	049515
11	049045	11	049295	11	049520
12	049050	12	049300	12	049525
13	049055	13	049305	13	049530
14	049060	14	049310	14	049535
15	049065	15	049315	15	049540
16	049070	16	049320	16	049545
17	049075	17	049325	17	049550
18	049080	18	049330	18	-
19	049085	19	049335	19	049555
20	049090	20	049340	20	-
21	049095	21	049345	21	-
22	049100	22	049350	22	049560
23	049105	23	049355	23	-
24	049110	24	049360	24	049565
25	049115	25	049365	25	-

Imperial		Imperial			
A/F	Order code Open End	A/F	Order code Ring End*	A/F	Order code Flared End
5/32	049150	5/32	049400	5/32	-
3/16	049155	3/16	049405	3/16	-
7/32	049160	7/32	049410	7/32	-
1/4	049165	1/4	049415	1/4	049600
5/16	049175	5/16	049420	5/16	049605
3/8	049185	3/8	049425	3/8	049610
7/16	049195	7/16	049430	7/16	049615
1/2	049200	1/2	049435	1/2	049620
9/16	049205	9/16	049440	9/16	049625
5/8	049210	5/8	049445	5/8	049630
11/16	049215	11/16	049450	11/16	-
3/4	049220	3/4	049455	3/4	049635
13/16	049225	13/16	049460	113/16	-
7/8	049230	7/8	049465	7/8	049640
15/16	049235	15/16	049470	15/16	-
1	049240	1	049475	1	049645

To convert 8mm Spigot to 1/4" Square Drive

Type	Order Code	Centre mm
1/4 Fixed	<b>A29071</b>	25

Type	Order Code	Centre mm
1/4 Ratchet	<b>A28990</b>	25



**For more information:** Tool Selector; [gedore-torque.com/tool-selector](http://gedore-torque.com/tool-selector) Telephone; +44 (0) 1483 894 476  
Videos; [www.youtube.com/gedore-torque](http://www.youtube.com/gedore-torque) Email; [salesandrepairs@gedore-torque.com](mailto:salesandrepairs@gedore-torque.com)

Want to know how  
to use this tool?  
**YouTube**  
Watch our video

# Torque Wrench End Fittings

## 16 mm Spigot Type

Metric & Imperial Accessories compatible with the following Torque Wrenches:

ATB Adjustable Breaking Torque Wrenches, models ATB 25, 50 & 100.  
**See page 49**

TBN Preset Breaking Torque Wrenches, models 25, 65, 135 & 200.  
**See page 38-39**

Torcofix Production Clicker Torque Wrenches. **See page 50-51**

TSC Adjustable Slipping Torque Wrenches. **See page 45**



Open End



Ring End



Flared End



Blank End Fitting  
16 mm Spigot Type  
Order Code: A55230

Available to customers wishing to make special spanner end attachments



Square Drive  
16 mm Spigot Type  
Order Code:  
3/8" - 029040  
1/2" - 029060



Ratchet Head  
Square Drive  
16 mm Spigot Type  
Order Code:  
3/8" - 029010  
1/2" - 029030

←		Metric		→	
A/F	Order code Open End	A/F	Order code Ring End	A/F	Order code Flared End
7	026020	7	027220	7	028190
8	026040	8	027240	8	028200
9	026060	9	027260	9	028210
10	026080	10	027280	10	028220
11	026100	11	027300	11	028240
12	026120	12	027320	12	028260
13	026140	13	027340	13	028280
14	026160	14	027360	14	028300
15	026180	15	027380	15	028320
16	026200	16	027400	16	028340
17	026220	17	027420	17	028360
18	026240	18	027440	18	028380
19	026260	19	027460	19	028400
20	026280	20	027480	20	028420
21	026300	21	027500	21	028440
22	026320	22	027520	22	028460
23	026340	23	027540	23	028480
24	026360	24	027560	24	028500
25	026380	25	-	25	-
26	026400	26	027600	26	-
27	026420	27	027620	27	028520
30	026440	30	-	30	-
32	026460	32	-	32	-

←		Metric		→	
A/F	Order code Open End	A/F	Order code Ring End	A/F	Order code Flared End
5/16	026620	5/16	027720	5/16	-
3/8	026640	3/8	027740	3/8	028600
7/16	026650	7/16	027750	7/16	028620
1/2	026660	1/2	027760	1/2	028640
9/16	026680	9/16	027780	9/16	028660
5/8	026690	5/8	027790	5/8	028680
11/16	026700	11/16	027800	11/16	028700
3/4	026710	3/4	027810	3/4	028710
13/16	026720	13/16	027820	13/16	028720
7/8	026740	7/8	027840	7/8	028740
15/16	026750	15/16	027850	15/16	028750
1	026760	1	027860	1	028760
11/16	026770	11/16	027880	11/16	028770
11/8	026780	11/8	-	11/8	028780
13/16	026800	13/16	027920	13/16	028800
11/4	026820	11/4	-	11/4	-



Hex Key Adaptors

Order Code	Hex Key Sizes
	⌘ mm ⌘
<b>A38940</b>	2.5 - 5.0
<b>A38950</b>	6.0 - 8.0



# Rectangular End Fittings

## 9x12mm Type



← Metric →		Metric			
A/F	Order code Open End	A/F	Order code Ring End	A/F	Order code Flared End
7	7688390	7	7691340	7	-
8	7688550	8	7691420	8	-
9	7679050	9	-	9	-
10	7688630	10	7691690	10	7685290
11	7688980	11	7691770	11	7685370
12	7679560	12	7677940	12	7699590
13	7689010	13	7691930	13	7679210
14	7689360	14	7692230	14	7679480
15	7689440	15	7692580	15	-
16	7679990	16	7678080	16	-
17	7689600	17	7692740	17	7685880
18	7684560	18	7678160	18	7679640
19	7689790	19	7692820	19	7686260
20	-	20	-	20	-
21	-	21	7678240	21	-
22	-	22	7693040	22	7679720

## Accessories compatible with the following Torque Wrenches:

Torcofix Adjustable Clicker Torque Wrenches, models 25SE, 50SE & 100SE. **See page 51**

TBN Preset Breaking Torque Wrenches, models 2G, 10G, 25G, 65G & 135G. **See page 39**



## Reversible Ratchet Head Fixed square Head

Type	Order Code
1/4	<b>7672710</b>
3/8	<b>7686500</b>
1/2	<b>7687230</b>

Type	Order Code
1/4	<b>7672630</b>
3/8	<b>7679800</b>
1/2	<b>7687900</b>

# Hexagon Nut Sockets

Metric & Imperial Accessories to complement our range of Standard and Insulated Torque Wrenches (pages 40-41)



## 1/4" Square Drive Hexagon Nut Sockets

← Metric →			← Imperial →			← Imperial →		
Type	Order code	A/F	Type	Order code	A/F	Type	Order code	A/F
NS 4	030500	4	NS 8BA	031100	.152	NS 187	030800	3/16
NS 4.5	030520	4.5	NS 7BA	031120	.172	NS 219	030820	7/32
NS 5	030540	5	NS 6BA	031140	.193	NS 234	030840	15/64
NS 5.5	030560	5.5	NS 5BA	031160	.220	NS 250	030860	1/4
NS 6	030580	6	NS 4BA	031180	.248	NS 266	030880	7/64
NS 7	030600	7	NS 3BA	031200	.282	NS 281	030900	9/32
NS 8	030620	8	NS 2BA	031220	.324	NS 312	030920	5/16
NS 9	030640	9	NS 1BA	031240	.365	NS 344	030940	11/32
NS 10	030660	10	NS 0BA	031260	.413	NS 375	030960	3/8
NS 11	030680	11	-	-	-	NS 437	030980	7/16
NS 12	030700	12	-	-	-	NS 500	031000	1/2
NS 13	030720	13	-	-	-	-	-	-
NS 14	030740	14	-	-	-	-	-	-

## Metric Insulated Nut Sockets

← 50V for Low Voltage Applications →	
A/F	Order Code 1/4" in Drive
8	030620A11030
10	030660A11030
11	-
12	030700A11030
13	030720A11030
14	030740A11030
16	-
17	-
18	-

Other sizes available on request

**For more information:** Tool Selector; [gedore-torque.com/tool-selector](http://gedore-torque.com/tool-selector) Telephone; +44 (0) 1483 894 476  
Videos; [www.youtube.com/gedore-torque](http://www.youtube.com/gedore-torque) Email; [salesandrepairs@gedore-torque.com](mailto:salesandrepairs@gedore-torque.com)

Want to know how to use this tool?  
**YouTube**  
Watch our video

# Torque Screwdriver Accessories

Accessories to complement our range of Torque Screwdrivers (see page 18)  
Please note Screwdriver dimensions may change subject to availability



1/4" A/F Hexagon Shank Bits & Blades for use with all 1/4" FH Screwdrivers

Blade				Pozidriv				Phillips				Torx			
Type	Order code	Size	↳ mm ↲	Type	Order code	Size	↳ mm ↲	Type	Order code	Size	↳ mm ↲	Type	Order code	Size	↳ mm ↲
3	029300	3 mm x 0.5	39	No. 0	029500	No. 0	25	No. 0	029600	No. 0	25	TX6	029740	1.65	25
4.5	029320	4.5 mm x 0.6	39	No. 1	029520	No. 1	50	No. 1	029610	No. 1	50	TX8	029760	2.28	25
5.5	029340	5.5 mm x 0.8	39	No. 2	029540	No. 2	50	No. 2	029620	No. 2	50	TX10	029770	2.72	25
6.5	029360	6.5 mm x 1.2	39	No. 3	029560	No. 3	50	No. 3	029640	No. 3	50	TX20	029780	3.84	25
8	029380	8 mm x 1.6	39	-	-	-	-	-	-	-	-	TX25	029790	4.39	25

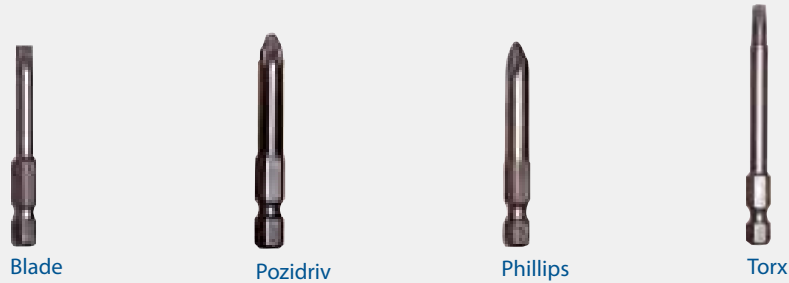

Blade			Pozidriv			Phillips			Torx		
Type	Order code	↳ mm ↲	Type	Order code	↳ mm ↲	Type	Order code	↳ mm ↲	Type	Order code	↳ mm ↲
3 x 0.5	029305	50	No. 0	029505	50	No. 0	029605	50	TX06	029745	50
4 x 0.5	029325	50	No. 1	029525	50	No. 1	029615	50	TX08	029765	50
5.5 x 0.8	029345	50	No. 2	029545	50	No. 2	029625	50	TX10	029775	50
6.5 x 1.2	029361	50	No. 3	029565	50	No. 3	029645	50	TX20	029785	50

## Lock on T-Bar

Extra leverage provided with removable T-Bar for larger screwdriver models

Accidental tool disengagement is prevented through the Lock On feature









Order Code:  
P29530

# Torque Screwdriver Accessories

Accessories to complement our range of Torque Screwdrivers (see page 18)

## Converters & Adaptors

Type	Order code	To Convert Tool Drive		k mm
		From	To	
FSHA	A35640			30 (1 1/8")
Converter	029200			50 (2")
MSHA	A25420			25



FSHA



Converter



MSHA

## Inline Freewheel Adaptor

Type	Order code	To Convert Tool Drive Torque		Freewheel
		From	To	
FWA-R	A8842R	Clockwise	Anticlockwise	
FWA-L	A8842L	Anticlockwise	Clockwise	



Absorbs unwanted shock loads by transmitting torque in one direction and freewheeling in the opposite direction

Roller clutch for minimal backlash and drag

## Special Crowsfoot Spanner Ends

Order Code	A/F Size
C62890	3/8 in
C62891	1/2 in
C62898	6 mm
C62892	8 mm



**For more information:** Tool Selector; [gedore-torque.com/tool-selector](http://gedore-torque.com/tool-selector) Telephone; +44 (0) 1483 894 476  
Videos; [www.youtube.com/gedore-torque](http://www.youtube.com/gedore-torque) Email; [salesandrepairs@gedore-torque.com](mailto:salesandrepairs@gedore-torque.com)

Want to know how to use this tool?  
**YouTube**  
Watch our video



# The Torque Multiplier Accessories

Accessories to complement our range of torque multipliers (see pages 60-65)

**For more information on sizing & compatibility, please contact us on +44 (0) 1483 894 476**

## Accessories for the LKV-40 To LKV-120RS



Reaction arm cranked with lock on function, made of drop-forged chrome-vanadium steel (up to LKV-80)



Reaction arm cranked with lock on function, made of light alloy with protective cap made of steel (from LKV-100)



Reaction arm made of light alloy, straight with adjustable locking knob with moveable square-end and retaining ring (up to LKV-100)

## Accessories for the LKV-12



Reaction arm cranked with lock on function, made of drop-forged chrome-vanadium steel



Reaction arm made of light alloy, straight with adjustable locking knob with slave square and retaining ring



Sun gear

## Accessories for the LKV-20 and LKV-28



Reaction arm cranked (bolted to the tool)



Reaction arm made of light alloy, straight with adjustable locking knob with reaction slave square (bolted to the tool)



Spare square for LKV-20



Spare square for LKV-28

# The Torque Multiplier – The Function principle

The principle of torque multiplication

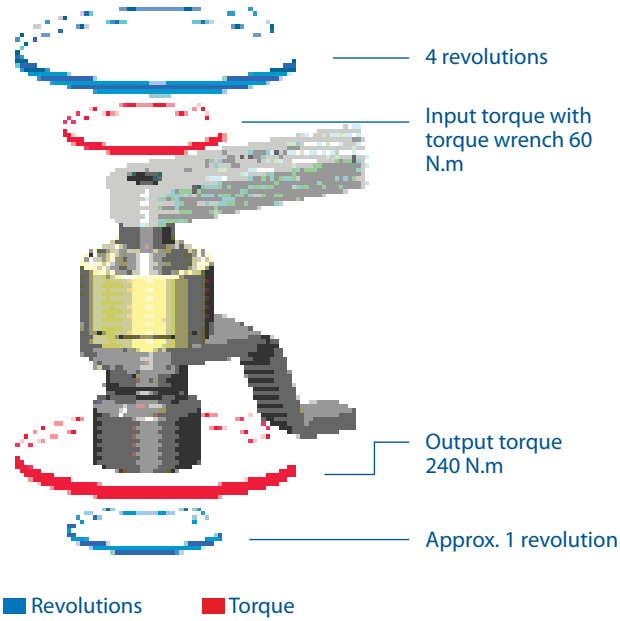

The diagram representation demonstrates the principle of torque multiplication. Let us assume a 60 N.m input torque and a 240 N.m output torque. At a 1:4 ratio, 4 revolutions are needed at the 60 N.m input for 1 revolution with a 240 N.m torque to be obtained at the output.

This is based on the physical formula:

$$\text{Power} = \text{torque} \times \text{revolution}$$

With gear efficiency deducted, the output power can be considered as a constant equal to the input power. Thus multiplication of the torque can only be obtained from an increased number of revolutions at the input.

## Force and reaction

When working with a torque multiplier, torsion wind-up is built up in the gear while the bolt is tightened. This stress must be reduced. A reaction absorbed by reaction arm and thrust bearing is produced.

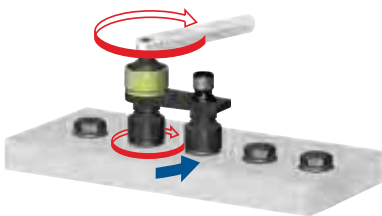

Reaction arm made of light alloy, straight with adjustable locking knob with slave square: The reaction acts on the adjacent impact socket

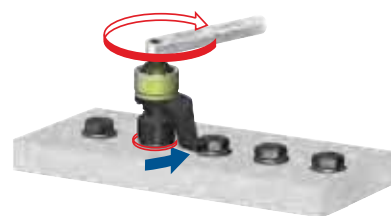

Reaction arm cranked: The reaction acts on the adjacent bolt connection

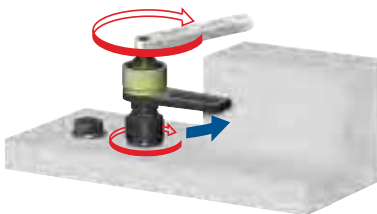

Reaction arm straight without adjustable reaction square drive: The reaction acts on the wall. However, the resulting tilting moment means that the maximum permitted torque is reduced by 20%.



**For more information:** Tool Selector; [gedore-torque.com/tool-selector](http://gedore-torque.com/tool-selector) Telephone; +44 (0) 1483 894 476  
Videos; [www.youtube.com/gedore-torque](http://www.youtube.com/gedore-torque) Email; [salesandrepairs@gedore-torque.com](mailto:salesandrepairs@gedore-torque.com)

Want to know how to use this tool?  
**YouTube**  
Watch our video

# The Cordless Torque Wrench Accessories

Accessories to complement our range of Cordless Torque Wrench (see pages 65-65)

**For more information on sizing & compatibility, please contact us on +44 (0) 1483 894 476**

## Accessories for the LDA/LAW SERIES, 90 - 6.000 N.m



Charger 110V/60Hz; 220V/50Hz



140 Wh Battery (28 V / 5 Ah)



Charger with 12/24V connector



Hybrid cube mains battery pack



Reaction ring for bespoke reaction arm design

## Reserve capacity of battery and charger



The charging time on the charger is approx. 30-50 min when the battery is empty. Once the battery is fully charged, the charger LED changes from red to green



Lithium ion technology



Discharging during work



The flashing LED signals that the battery has a reserve capacity of 10%

Pressure switch for displaying the charge status



Four lit up LEDs signal that the battery is fully charged



# Bar Code Scanners

## WCS3900 CCD Scanner

This barcode scanner enables linear (1D) barcodes to be captured quickly and easily. A connection to a PC is all that is required to add barcode data to an active application.



**Accuracy and efficiency.** Barcode data can be instantly added to your active application, without time-consuming manual data entry or errors

**Ease of installation and use.** Once the scanner is connected to a PC by USB or PS2, it is ready for use, without additional software or drivers. Data is entered automatically

**Long tool life.** Robust, high quality construction ensures reliability and many years of dependable service. CCD scan engine and high-quality construction prevent breakage

**Operational versatility.** Decodes commonly used linear (1D) barcodes, including Code 39, Code 129 and UPC

**Production efficiency.** Ergonomic design provides comfortable use, hence reducing operator fatigue

### Additional features

Pair the WCS3900 with the optional stand for convenient desktop storage

Scans barcodes up to 3.25 inches wide from 1 inch away

CCD scan engine and high-quality construction prevent breakage

Includes 6-foot USB or PS/2 cable

Conforms to FCC Class A and CE requirements

## WWR2900 Pen Scanner

This pen-style barcode scanner enables scanned data to be captured quickly and easily, particularly for repetitive jobs. A connection to a PC is all that is required to add barcode data to any DOS or Windows application and view it on screen as it is scanned.

**Accuracy and efficiency.** Barcode data can be instantly added to your active application, without time-consuming manual data entry or errors

**Ease of installation and use.** Once the scanner is connected to a PC by USB or PS2, it is ready for use, without additional software or drivers. Data is entered automatically

**Long tool life.** Robust construction ensures reliability and many years of dependable service. Manufactured from high quality ABS plastic

**Operational versatility.** Decodes commonly used linear (1D) barcodes, including Code 39, Code 129 and UPC

**Production efficiency.** Ergonomic, lightweight, desktop design requires minimal space. Soft grip for comfortable use, hence reducing operator fatigue and making the scanner suitable for repetitive jobs

### Additional features

Conforms to FCC Class A and CE requirements



For more information contact us on **+44 (0) 1483 894 476**

Model	Dimensions	Weight
Pen Barcode Scanner WWR2900 (With USB cable)	H 29.6 x W 150 x D 22 mm	76 g
Pen Barcode Scanner Stand	-	-
CCD Barcode Scanner WCS3900 (With USB cable)	L 18.8 x H 2.7 x W 9.2 cm	125 g (without cable)
CCD Barcode Scanner WCS3900 (With PS2 cable)	L 18.8 x H 2.7 x W 9.2 cm	125 g (without cable)
CCD Barcode Scanner Stand	-	-

# Convertors and Adaptors

Accessories to complement our range of Torque Screwdrivers and Wrenches

## Socket Blanks

Type	Order code	Metric Dimensions		
		A	B	C
SB2	A15720	1/4	5/8	7/8
SB3	A16200	3/8	13/16	1 1/8
SB4	A16210	1/2	1	1 1/4
SB5	A14790	3/4	1 1/2	2 5/16
SB6	A14800	1	2	2 9/16

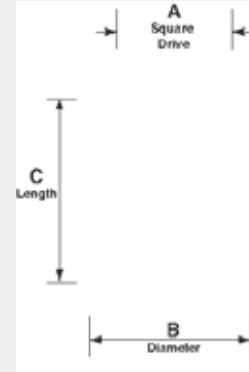

## Converters

Type	Order code	To Convert Tool Drive	
		From	To
DSAP	031320	1/4	3/8
DPAS	031300	3/8	1/4
ASEP	031340	3/8	1/2
APES	031360	1/2	3/8
ESHP	031380	1/2	3/4
EPHS	031400	3/4	1/2
HSGP	031420	3/4	1
HPGS	031440	1	3/4

From



To

## Hexagon Key Bits

Metric				Imperial				Imperial			
Type	Order Code	A/F	mm	Type	Order Code	A/F	mm	Type	Order Code	A/F	mm
IB 1.5	030100	1.5	25	IB 093	030300	3/32	25	G2	B1607A	.035	35
IB 2	030120	2	25	IB 109	030310	7/64	25	G3	B1607B	.050	35
IB 2.5	030140	2.5	25	IB 125	030320	1/8	25	G4	B1607C	.062	35
IB 3	030160	3	25	IB 141	030330	9/64	25	G5	B1607D	5/64	35
IB 4	030180	4	25	IB 156	030340	5/32	25	-	-	-	-
IB 5	030200	5	25	IB 187	030360	3/16	25	-	-	-	-
IB 6	030220	6	25	IB 281	030380	7/32	25	-	-	-	-
IB 7	030240	7	25	IB 250	030400	1/4	25	-	-	-	-
IB 8	030260	8	25	IB 312	030410	5/16	25	-	-	-	-

Note: **IB Bits** will require 1/4" FSHA Adaptor unless your tool is already a 1/4" FH Drive

Integral 1/4" Square Drive



# Special Extension Spanners & Adaptors

Accessories to complement the Dial Measuring Wrench Range (page 12)

When design or space limitations preclude the use of a Dial Measuring Wrench and a standard Nut Socket, special Extension Spanners can be manufactured.

These allow access and enable you to apply Torque in awkward spaces. See illustrations for typical examples.

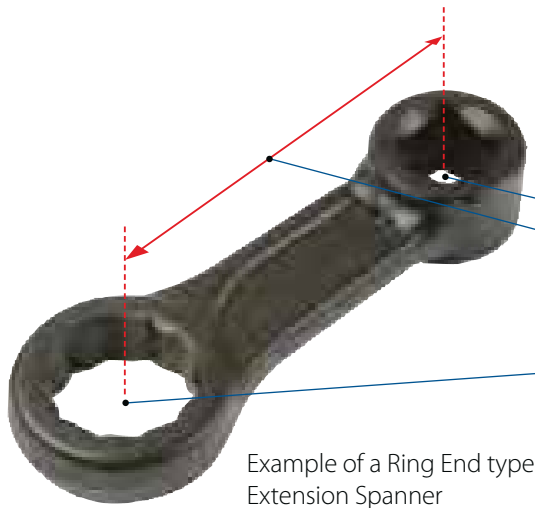

Example of a Ring End type Extension Spanner

## To order a Special Extension Spanner

To order please supply the following information:

- Square drive size
- Centred distance between the square drive and the spanner end fitting
- A/F size of spanner end
- End type - Ring, Open or Flared
- Maximum Torque to be applied
- A fully dimensioned drawing

## Table of Effective Wrench Lengths across our Range

Model Ranges	Effective length k mm
ADS 12/25/40	190
BDS 80	368
BDS 160/200	445
CDS	635
DDS	850
EDS	1727

Special Extension Spanners are not recommended for ADS 4 & 8

## Extension Adaptors for ADS & BDS Wrenches where space is restricted

Adaptor Model	Order code	Drive	
16mm Spigot	A96102	$\frac{3}{8}$ "	
	A96103	$\frac{1}{2}$ "	
German 9x12	A96112	$\frac{3}{8}$ "	
Cavity Fitting	A96113	$\frac{1}{2}$ "	
Wedge Fitting	A96122	$\frac{3}{8}$ "	
	A96123	$\frac{1}{2}$ "	

Measure dimension of Adaptor & End Fitting for E (see diagram above)

## How to Calculate the True Torque when using Extension Spanners

When using Extension Spanners the dial reading will not display the correct torque being applied. To ensure **True Torque** see the formula on the right to recalculate

Effective Wrench Length - L

Extension Length - E

Dial Reading - DR

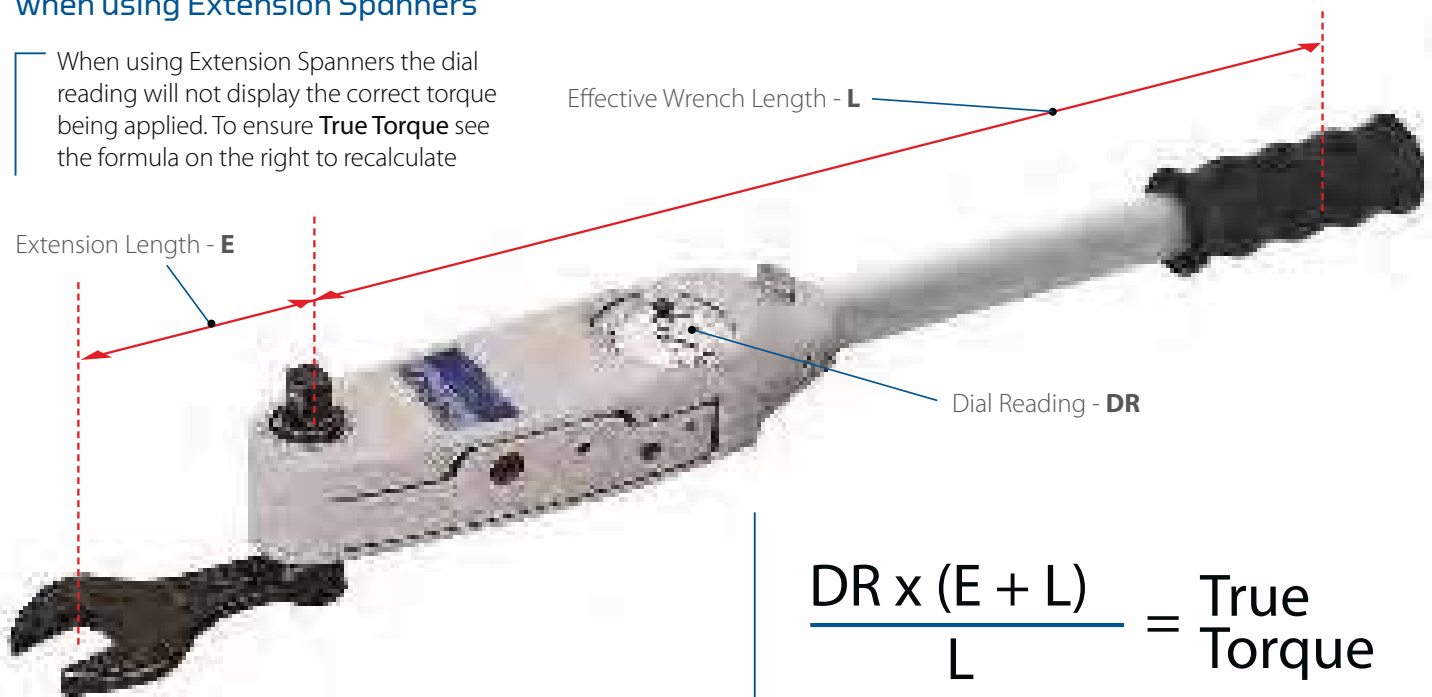

$$\frac{DR \times (E + L)}{L} = \text{True Torque}$$



## Our Worldwide Commitment to Service

From our base in the UK, Gedore Torque provides unparalleled technical information, services and support in the UK and worldwide, with its network of factory-trained distributors.

Our commitment to Quality Assurance and Standards includes conformance with national and international standards and our own UKAS-accredited Calibration Laboratory.

With a worldwide network of factory-trained distributors, we can offer high levels of service and support, wherever you are.

### **In this section you'll find information about the following:**

Calibration Service and Repairs

Quality Assurance and Standards

Calibration and Traceability

Information on Torque



**Mawuli Austin, Service Technician**

*In the calibration laboratory, we are committed to absolute precision and consistent accuracy. I am proud that every day, we achieve national and international standards on behalf of our customers.*

## UK Head Office

Contact us for any technical information or support that you may need.

Tannery Lane, Gosden Common, Bramley,  
Guildford, Surrey GU5 0AJ

Phone: +44 (0) 1483 894 476  
+44 (0) 1483 892 772

Fax: +44 (0) 1483 898 536

Email: [salesandrepairs@gedore-torque.com](mailto:salesandrepairs@gedore-torque.com)



## Technical Support

For expert technical advice, contact us by phone or email. If there is a problem to be discussed, or you would like a product demonstration, a visit to your site by one of our Technical Managers can be arranged.



## Distributors

With 74 Distributors in 51 countries, our products are available and supported worldwide. All Distributors are factory-trained and are able to give a full service and to offer expert advice. Contact us (details above) for your local distributor, or visit [www.gedore-torque.com](http://www.gedore-torque.com)



## Website

Our website contains a wealth of product information, including a Knowledge Centre and Tool Selector - [www.gedore-torque.com/tool-selector](http://www.gedore-torque.com/tool-selector)

## Videos

Our YouTube channel contains videos showing how to use most of our tools. [www.youtube.com/gedore-torque](http://www.youtube.com/gedore-torque)



## Social Media



[twitter.com/GedoreTorque](https://twitter.com/GedoreTorque)  
[www.facebook.com/GedoreTorqueUK/](https://www.facebook.com/GedoreTorqueUK/)  
[www.linkedin.com/company/torqueleader](https://www.linkedin.com/company/torqueleader)  
[plus.google.com/+TorqueleaderUK](https://plus.google.com/+TorqueleaderUK)

# Taking Care of Your Tools

## Calibration, Servicing & Repair

When you buy from Gedore Torque, everything you need to maintain, service and repair your torque equipment is available in house, at our UK site. Regular re-calibration and servicing are essential if Torque Tools are to deliver absolute precision and consistent accuracy throughout their lifetime. What's more, today's Quality Assurance Systems demand

that measuring torque tools and calibration equipment are checked regularly and provided with traceable calibration certificates. For these reasons, Gedore Torque offers a comprehensive Calibration, Servicing & Repair service, to ensure that your tools continue to operate to the highest standards. And in most cases, we are able to provide a 24-hour turnaround.

### Torque Calibration

Torque Calibration ensures that torque equipment operates to peak performance, ensuring absolute and consistent accuracy and adherence to National and International standards

It also ensures that potential tooling problems are identified before they arise, hence ensuring that lifetime ownership costs are minimised

### Calibration Laboratory, Servicing and Repair Centre

Gedore Torque has a UKAS-accredited Calibration Laboratory, based at our site in the UK. Here, we are able to recalibrate most Hand Torque Tools, Analysers and Transducers in accordance with National and International Standards.

Our Calibration Laboratory offers an in-depth Torque Calibration Service. This provides:

Torque Wrench calibration to ISO 6789

Torque Sensor calibration to BS 7882

'As found' and 'As left' Calibration Certificates

UKAS Scope: Hand Tools 0.14-1000 N.m  
Transducers 0.2-3000 N.m

The technical competence of the Laboratory and its staff have been independently accredited by UKAS to ISO/IEC 17025. UKAS (the United Kingdom Accreditation Service) is the only national accreditation body recognised by the British Government to assess the competence of organisations that provide certification, testing, inspection and calibration services.

We can also accommodate tools from other manufacturers subject to inspection and acceptance. For more information, call us on: **+44 (0) 1483 894 476** or email: [salesandrepairs@gedore-torque.com](mailto:salesandrepairs@gedore-torque.com)



## In House Calibration Service

Our in house calibration service is a cost-effective method to ensure that your equipment is always in peak condition.

This provides:

Gedore Torque Calibration Certificates

Clear results

Traceability to National Standards

Tools that are accurate, precise and performing to the highest standard

## Servicing and Repairs

Our tools contain moving parts that require periodic servicing and lubrication. The recommended service interval is twelve months, 5000 cycles or more frequent if usage is high. And even in the best work environment, repairs are sometimes necessary.

That's why we offer a full and comprehensive After Sales Service. On return of any product, the work necessary to bring the torque tool to first class condition is assessed and the customer advised of the cost involved. Once the customer has given their permission to proceed, the work is carried out to an agreed timescale.

If you choose to do your own servicing, the following lubrication tables give details of the recommended oils and greases as used in our tools.

### Tool Lubrication Table For Gedore Torque Products

Lubricants - Correct at time of going to print									
Torque Wrenches	Fuchs Renolit CX1 2 Grease	Total Multis MS 2	Fuchs Renolit EP X1 PBF	Total Multis EP2	Silicon Grease RS 555-083	Shell Tonna 32 Lubricating Oil	Rocol Dry Moly Paste (ASP)	Amalgam of 75% Dry Moly Paste 25% Lubricating Oil	CX HT2 Grease
Dial Wrenches	ADS Ratchet & Pawl			BDS/CDS/DDS Ratchet & Pawl	Window Assembly 'O' Rings				
STB			Spring, Cam & Roller		'O' Rings	Ratchet & Pawl			
TSC & TSP	Bearings, TSC Locking Mechanism						Thrust Pin		
TSN			Spring, Cam & Roller		'O' Rings	Ratchet & Pawl			
TBN 2 & 10		Spring				Adj. Screw	Roller, Cam, Thrust Pad, Captive Pin		
TBN 25,65,135 & 200		Spring					Roller, Cam, Thrust Pad, Captive Pin	Trunnion, Adj. Screw	
ATB 5, 10, 25, 50, 100							Adj. Screw, Captive Pin, Int. Spring Adjuster, Lock Knob & Adj. Screw End, Ext. Handle		Spring, Ext. Spring Adjuster, Trunnion, Int. Handle

Lubricants - Correct at time of going to print							
Torque Screwdrivers & Analysers	Shell Stamina EP2 Grease	Total Multis EP2	Silicon Grease RS 555-083	NYE Rheolube 368 F Strained Grease	WD-40 Lubricant/Inhibitor	Renolin B3 - VG10	All Purpose 3 in 1
TT					Torsion Bars & Spring Clamps		Memory Assembly
Quickset, QSN & QSA	General Use Ball Housing	Handle Threads	'O' Rings				
TLS	General Use Spring Housing						
Cleanroom CRS				General Use Spring Housing			
MTS & MTP						Drive Spindle & Needle Bearings	
ISO 1000 & ISO 1500		Multiplier & Worm Gearbox					

**For more information:** Tool Selector; [gedore-torque.com/tool-selector](http://gedore-torque.com/tool-selector) Telephone; +44 (0) 1483 894 476  
Videos; [www.youtube.com/gedore-torque](http://www.youtube.com/gedore-torque) Email; [salesandrepairs@gedore-torque.com](mailto:salesandrepairs@gedore-torque.com)

Want to know how to use this tool?  
  
Watch our video

# Quality Standards

Our commitment to excellence means that our own business and the tools we manufacture conform to the appropriate National and International Standards. This means that you can be assured that our products are manufactured to the highest quality standards for absolute accuracy, consistency and precision.



FM00363



Gedore Torque is assessed and registered to **BS EN ISO 9001:2015 Certificate FM 00363**

All Gedore Torque tools are manufactured to the relevant British and International Engineering Standards and conform to the International Standard on Torque Tools **ISO 6789** and on transducers **BS7882** or as specified.

## The International Standard ISO: 6789 for Hand Torque Tools states:

- The effective working range of a tool
- The accuracy requirements for Torque Screwdrivers are +/- 6% of reading and for Torque Wrenches are +/- 4% of reading or +/- 6% for Torque Wrenches below 10 N.m
- The maximum torque value for each hex & square drive size
- Scale and marking requirements

- An overload ability of 125% of maximum torque capacity
- A calibration interval of 5000 cycles or 12 months
- Test and measuring procedures at 23° +/- 5°C
- The maximum permissible uncertainty of measurement of the calibration device shall be +/-1% of the indicated value

## Explanation on Terms

- Accuracy** of Measuring and Calibrated Scale Tools is their ability to deliver the torque as set on their scale, dial or digital display. This is usually expressed as a percentage of the target torque
- Resolution** of Measuring and Calibrated Scale Tools is the number of divisions that their full torque range is divided into. This can be displayed as decimal places on a digital display, number of divisions on a dial or graduations on a scale
- Repeatability** of Preset Tools is the ability to consistently apply the same torque in subsequent tightening operations. This is usually expressed as a percentage of the preset torque

## Explanation on Serial Numbers

All new and newly reconditioned Gedore Torque tools are marked with a serial number that enables **Complete Traceability**. This number is stored together with other data such as the original works order number and calibration details

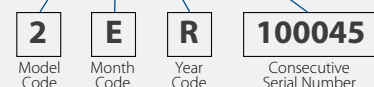

A = January...      A = 2002...  
 E = May              P = 2016  
 M = December.    R = 2017

# Calibration: Certification & Traceability

Regular Torque Tool Calibration and re-calibration guarantees the operator repeatable accuracy and adherence to international standards. To guarantee this, all Tools that have been calibrated or re-calibrated by Gedore Torque come with a Certificate of Calibration. This in turn provides confirmation that all equipment used by us has certification traceable to International Standards.

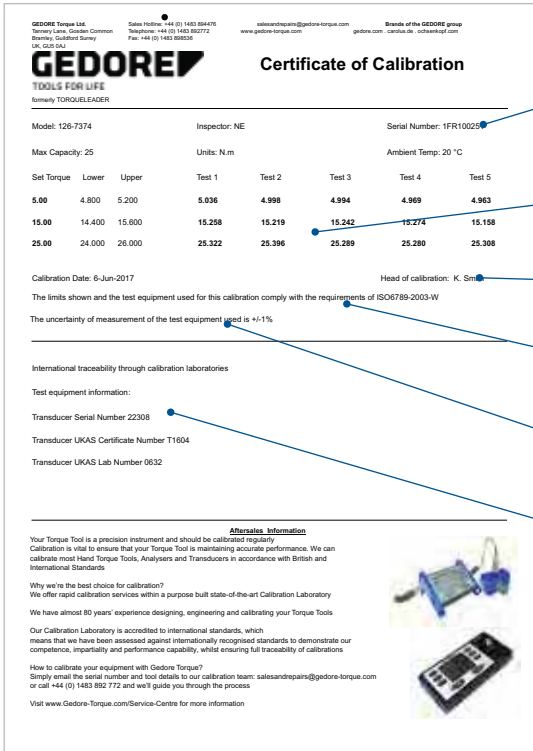

**Tool Identification Section...** for easy identification of the tool, its maximum capacity and its individual serial number

**Test Result Section...** gives the normal point at which the tool was tested, the tolerances and the actual results obtained

**Certification Section...** date and approval signature of test

**Standard Section...** confirms the standard requirements to which the tool complies

**Note Section...** gives information regarding slave pointers etc

**Traceability Section...** the serial numbers of the test equipment and the route back to National Standards

Gedore Torque's testing and calibration procedures are performed using equipment traceable to National Standards

## Traceability to International Standards

All equipment used by us in the Calibration of Torque Tools is regularly checked to ensure that the results obtained are accurate. All Calibration Equipment is itself assessed using equipment with certification traceable to International Standards.

## Returns policy

Gedore Torque Limited operates a returns number system for any tools that need to be returned for warranty repair or credit. The purpose of this is to enable us to track all returns back into the company to ensure a quick resolution to any warranty claims. If for any reason you need to return a tool to us within the warranty period, please contact the sales department on **01483 894476** or at **salesandrepairs@gedore-torque.com** beforehand. This ensures that the return is logged and a returns number is provided. Thank you for your co-operation, which will enable us to help you more quickly.

## Warranty Period

All our tools come with a two year warranty.

**UKAS Accreditation Certificate for Gedore Torque's Calibration Laboratory & Personnel**





# An Explanation of Torque

## Information on Measuring Torque

What you need to know to avoid incorrect tightening

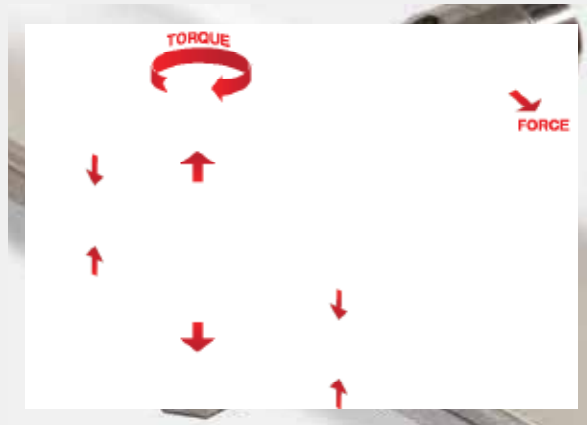

Torque is the application of a **Force** acting at a radial **Distance** and tending to cause rotation. Torque is used to create tension in threaded fasteners

When the nut and bolt are tightened the two plates are clamped together. The thread converts the applied torque into tension in the bolt shank. This in turn is converted into a clamping force. The amount of tension created in the bolt is critical

### Explanation on the creation of a Clamping Force

The tension in the bolt creates a clamping force (generally referred to as the preload) between the two parts

If the clamping force is too low, the fasteners can work loose due to vibration or movement between the component parts

If a clamping force is too high, the fastener may permanently stretch and no longer apply the required clamping force

In severe cases the fastener may fail in assembly or during use when under load

### Explanation on how Torque is Calculated

Torque is the result of multiplying the value of **Force** applied by the **Distance** from the point of application

Comparing the two examples see below (A and B) the same resultant torque can be achieved with a lower Force if the Distance from the nut/bolt is increased

Some Torque Wrenches are length dependent that means that the actual torque applied to the fastener varies if the hand position on the wrench is varied - even with the wrench preset. This occurs if the pivot point of the wrench mechanism is not coincidental with the centre of rotation of the fastener

### Force x Distance = Torque (See right)

Example A:  $20\text{ N} \times 1\text{ m} = 20\text{ N.m}$

Example B:  $10\text{ N} \times 2\text{ m} = 20\text{ N.m}$

Some Torque Wrenches are **length dependent** that means that the actual torque applied to the fastener varies if the hand position on the wrench is varied - even with the wrench preset. This occurs if the pivot point of the wrench mechanism is not coincidental with the centre of rotation of the fastener

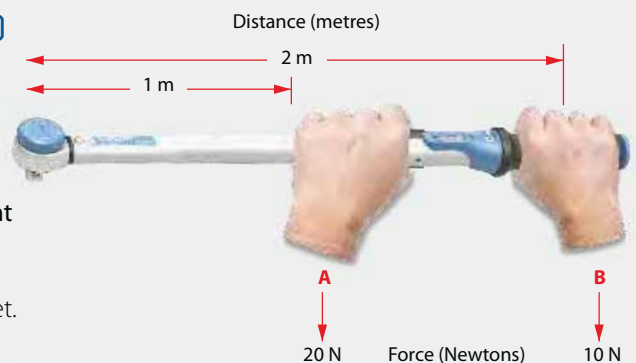

# Conversion Factors & Maximum Recommended Tightening Torques

Need help... call us on +44 (0) 1483 894 476

Units to be converted	Conversion Factors								
	mN.m	ISO cN.m	N.m	ozf.in	Imperial lbf.in	lbf.ft	gf.cm	Metric kgf.cm	kgf.m
1 mN.m	1	0.1	0.001	0.142	0.009	0.0007	10.2	0.01	0.0001
1 cN.m	10	1	0.01	1.416	0.088	0.007	102	0.102	0.001
1 N.m	1000	100	1	141.6	8.851	0.738	10197	10.20	0.102
1 ozf.in	7.062	0.706	0.007	1	0.0625	0.005	72	0.072	0.0007
1 lbf.in	113	11.3	0.113	16	1	0.083	1152.1	1.152	0.0115
1 lbf.ft	1356	135.6	1.356	192	12	1	13826	13.83	0.138
1 gf.cm	0.098	0.01	0.0001	0.014	0.0009	0.00007	1	0.001	0.00001
1 kgf.cm	98.07	9.807	0.098	13.89	0.868	0.072	1000	1	0.01
1 kgf.m	9807	980.7	9.807	1389	86.8	7.233	100000	100	1

Conversion Factors				
Thread Diameter (mm)	Hex Key Size (mm)	Hex Key Size (mm)	Hex Key Size (mm)	Hex Head Size (mm)
M 2	-	1.5	1.27	4
M 2.5	-	2	1.5	5
M 3	2	2.5	2	5.5
M 4	2.5	3	2.5	7
M 5	3	4	3	8
M 6	4	5	4	10
M 7	-	-	-	11
M 8	5	6	5	13
M 10	6	8	6	17
M 12	8	10	8	19
M 14	-	-	-	22
M 16	-	14	10	24
M 18	-	-	-	27
M 20	-	17	12	30
M 22	-	-	-	32
M 24	-	-	-	36
M 27	-	-	-	-

Recommended Maximum Tightening Torques N.m		
Bolt Grade 8.8	Bolt Grade 10.9	Bolt Grade 12.9
0.37	0.52	0.63
0.86	1.21	1.45
1.3	1.9	2.3
3.0	4.3	5.1
6.0	8.5	10.2
10.3	14.7	17.9
17.2	24.5	28.4
25.5	35.3	42.2
50.0	70.6	85.3
87.3	123	147
138	194	235
211	299	358
289	412	490
412	579	698
559	785	941
711	1000	1198
1049	1481	1775

These Torque values are for guidance only. Actual bolt load can vary by +/-30% based on finish, wear, coating, lubrication and manor of torque application.

Button Head



Cap Head



Countersunk Head



Hex Head Bolt



For more information: Tool Selector; [gedore-torque.com/tool-selector](http://gedore-torque.com/tool-selector) Telephone; +44 (0) 1483 894 476  
Videos; [www.youtube.com/gedore-torque](http://www.youtube.com/gedore-torque) Email; [salesandrepairs@gedore-torque.com](mailto:salesandrepairs@gedore-torque.com)

Want to know how to use this tool?  
**YouTube**  
Watch our video



Gedore Torque Ltd.  
Tannery Lane, Gosden Common, Bramley,  
Guildford, Surrey GU5 0AJ

Sales Hotline +44 (0) 1483 894 476  
Telephone +44 (0) 1483 892 772  
Fax +44 (0) 1483 898 536  
[salesandrepairs@gedore-torque.com](mailto:salesandrepairs@gedore-torque.com)  
[www.gedore-torque.com](http://www.gedore-torque.com)

**Brands of the GEDORE Group**  
[gedore-torque.com](http://gedore-torque.com) · [carolus.de](http://carolus.de) · [ochsenkopf.com](http://ochsenkopf.com)

formerly **TORQUELEADER**